

Gas supply equipment for industrial gas installations.

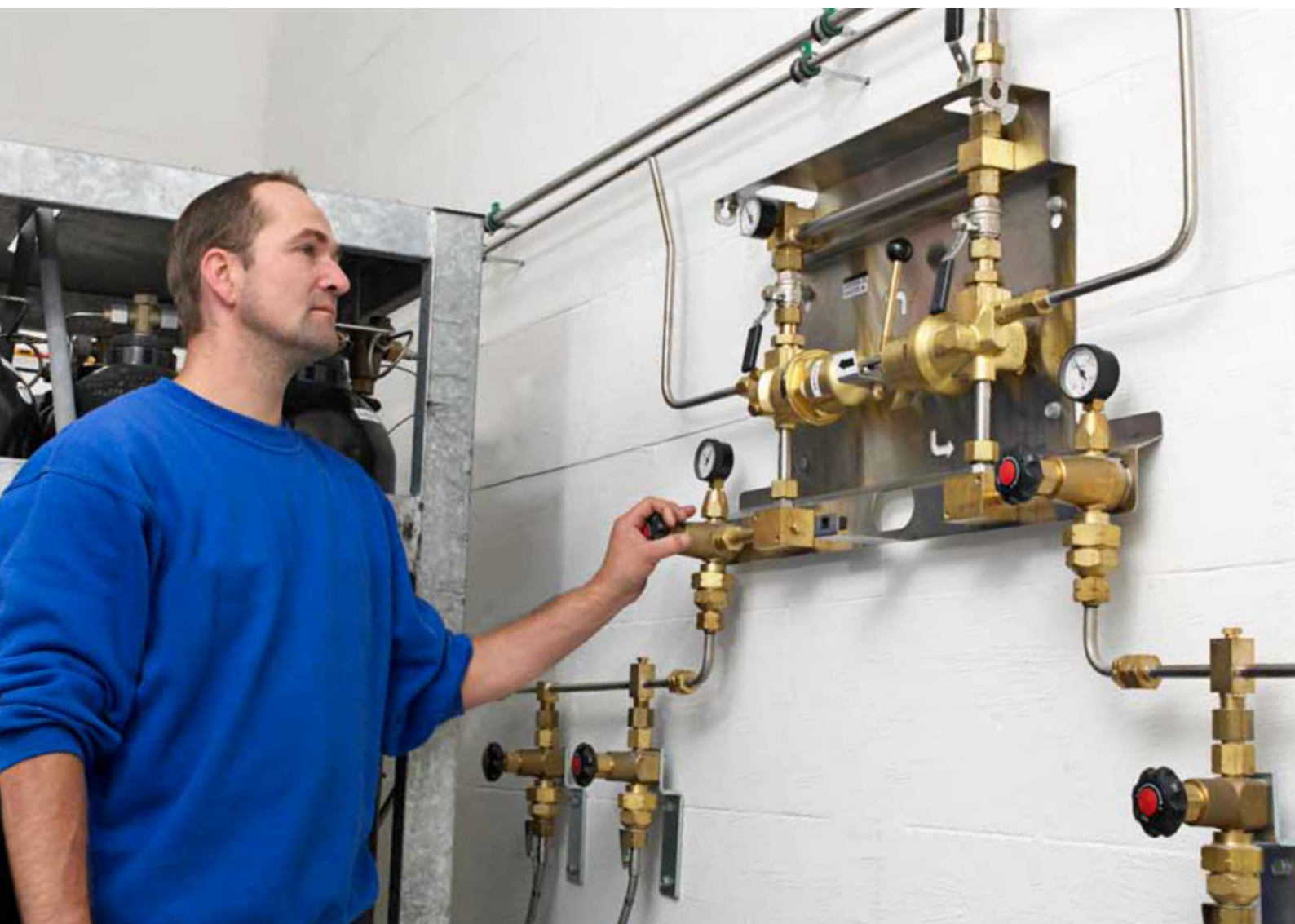

Contents.

- 04 Central gas supply
- 05 Advantages of central gas manifolds
- 06 Central gas supply
- 07 Advantages of a central gas system
- 08 Requirement of installations
- 09 SECCURA® automatic gas supply
- 10 Service and maintenance

Cylinder and bundle gas manifolds

- 11 SIMPLEX cylinder gas manifold
- 13 DUPLEX cylinder gas manifold
- 15 DUPLEX bundle gas manifold
- 17 BMD 100 - 39S semi-automatic cylinder gas manifold
- 19 MIC - 60 semi-automatic bundle gas manifold
- 21 AUTOFILL automatic bundle gas manifold
- 23 MANYFLOW cylinder gas manifold

Central regulator

- 24 Central regulator MR - 21
- 25 Central regulator MR - 60
- 26 Safety valve

High-pressure components

- 27 High-pressure hoses
- 29 High pressure manifold tube and anchor beams
- 30 High pressure components for central gas manifolds
- 31 Gas pre-heater 300W
- 32 Installation of pre-heater
- 33 High pressure valve DN 3 for combustible gases
- 33 High pressure valve DN 8 for combustible gases
- 34 High pressure valve DN 3 for oxygen and other air gases
- 34 High pressure valve DN 8 for oxygen and other air gases
- 35 Three-way valves
- 36 High-pressure valves DN 8 with wall bracket
- 37 High pressure filter

Low-pressure components

- 37 Non-return valve
- 38 Flashback arrestor Super 55
- 39 Flashback arrestor SAFE - GUARD - 4
- 40 Flame arrestor 85 - 10
- 41 Flame arrestor 85 - 30
- 42 Low pressure valves

Tapping points

- 44 JETSET shielding gas with one flowmeter
- 44 JETSET shielding gas with two flowmeters
- 45 JETSET shielding gas with manometer
- 45 JETSET nitrogen plasma cutting
- 46 JETSET oxygen single
- 47 JETSET oxygen single R64J
- 48 JETSET acetylene single
- 49 JETSET other combustible gases, single
- 50 JETSET combustible gas and oxygen, double
- 52 Tapping point for machine cutting, single
- 53 Tapping point for machine cutting, triple
- 54 Tapping point for machine cutting, single
- 55 Mobile tapping point argon and argon mixtures
- 56 Mobile tapping point acetylene and oxygen
- 57 Valve modules
- 58 Accessories for JETSET
- 59 Alarm for gas supply monitoring, GL2000
- 60 Alarm for gas monitoring AB-8
- 61 Contact gauges
- 62 Signs and labels

Introduction

This catalogue deals with products which Linde markets as central gas equipment for industrial cylinder gases, and which are used e.g. within the mechanical, food, and chemical industries. These products satisfy the standards and requirements which apply to pressurized equipment.

The equipment must be installed pursuant to the regulations that apply to central gas facilities. Contact Linde for information about regulations, design of the gas system, installation and technical service.

We reserve the right to change the appearance, shape and function of the products in keeping with product development and regulatory requirements.

This equipment is AGA's regional line of products. Some products will only be sold in certain countries.

Central gas supply.

System Design.

A complete system for efficient gas distribution consists of a central gas manifolds, a distribution network and tapping points.

The entire central gas manifold is in principle configured as shown in the sketch below. Central gas manifolds for gas cylinders or bundles are located in a room separated from the main building. The room can be an annex, a free-standing building, a special room in the building or a gas container.

In connection with the installation of a central gas manifold it is important that components and pipelines be chosen in accordance with the requirements made for central gas manifolds.

In the engineering phase it is important to be familiar with regulatory requirements, including requirements related to the supplier.

The most relevant standards for central-gas equipment relating to cutting, welding and heating processes are :

- EN 7291 - Regulators for manifolds
- EN 15615 - Acetylene manifold
- EN 14114 - Acetylene manifolds
- EN 730 - Safety device
- ISO 5175 - Safety device
- ISO 14113 High pressure hose

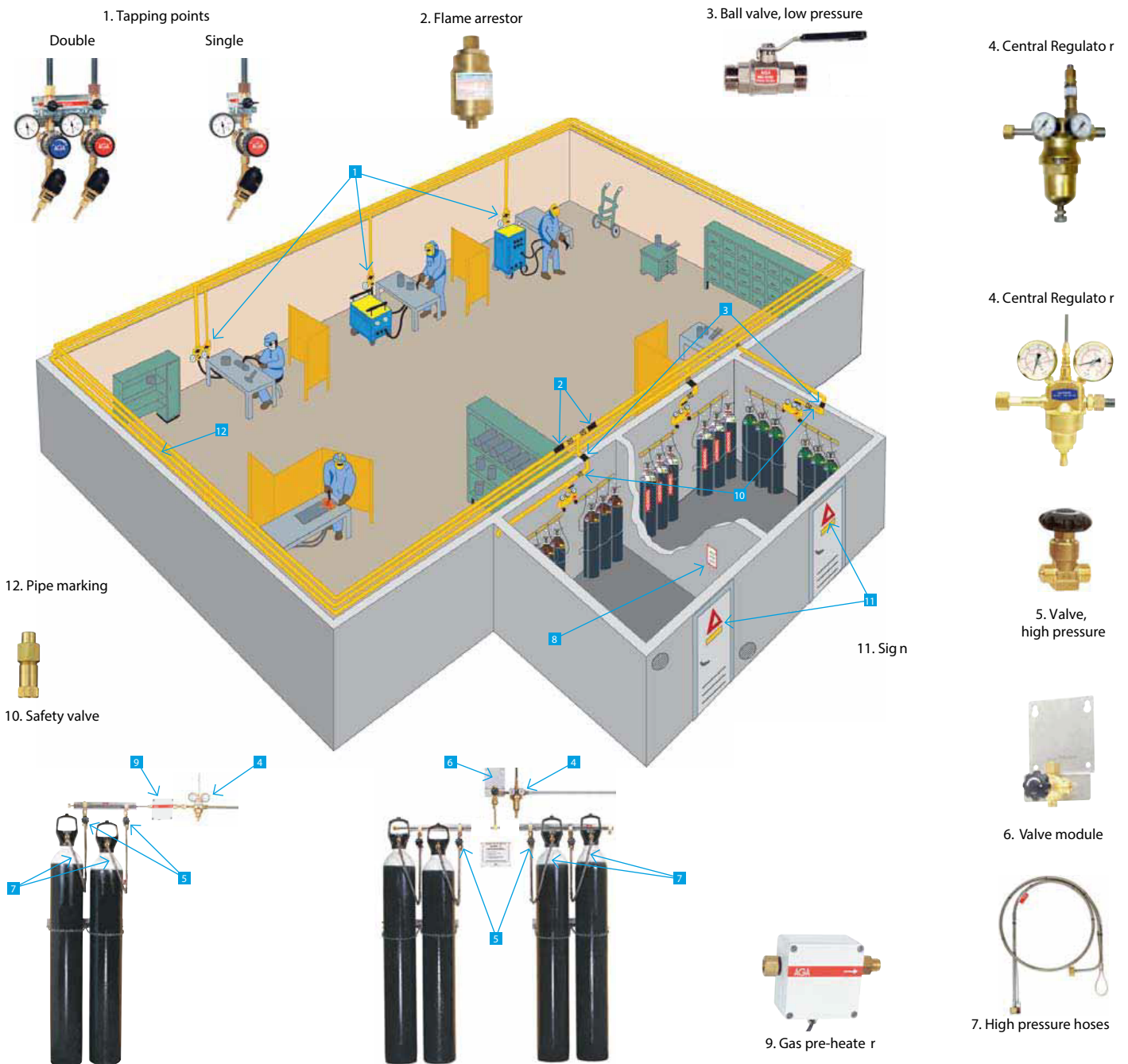

Advantages of a central gas system.

Time

- Continuous supply of gas to each work station.
- Limited transportation of gas cylinders in the workplace.
- Risk of disruptions can be limited by partially or fully automated central gas manifolds.
- Alarm signal equipment can give notice well before the gas cylinders are empty.
- Easy and safe distribution of the gas cylinders.

Workplace

- The gas cylinders are stored together in one location outside of the workplace.
- Better utilization of the work space.

Safety

- The risk of incidents and accidents is reduced because the gas cylinders are no longer handled inside the workplace.
- In the event of a fire, the gas cylinders are under better control.
- Only low pressure equipment in the workplace.

Economy

- Better emptying of the gas cylinders gives lower gas costs.
- Lower maintenance costs on gas equipment.
- Reduced cylinder rental due to fewer gas cylinders.
- External and internal transportation leads to cost reductions.
- More efficient gas supply gives reduced operating costs.

A central gas system functions in the following manner:

- The gas cylinders or gas bundles are connected to the central gas manifolds by high-pressure hoses.
- The gas cylinders are emptied through the central regulator in the central gas manifold. The central regulator's task is to reduce the cylinder pressure to a network pressure which is the correct entry pressure for the tapping points.
- From the central gas manifolds the gas is transported in a distribution network to all points of consumption.
- In the workplaces tapping points are installed according to the specification of the specific gas application. Approved gas hoses are used from the tapping points.

For high gas consumption, the central cylinder manifold can be replaced by a tank. This consists of a storage tank for liquid gas, an evaporator unit and associated regulators, valves and safety valves. For large-scale consumers of various mixed gases, there are in addition gas mixers which make the gas mixture on-site. Then gas is typically supplied from a cryo-tank or a central gas bundle manifold.



Container installation.

A complete gas container can be delivered as a turnkey solution for new central gas systems and based upon customer demands for the actual installation. The flexibility and cost efficiency of a turnkey solution is very suitable for many industrial customers where safe storage and easy handling of the gas cylinders are important.

The container solution fulfil all relevant regulations and can be equipped according to the list based upon customer demands.

Standard sizes of 8, 10 or 20 feet

Separate rooms for combustible and non-combustible gases

Doors with cylinder lock

Inlet for electrical connection

Explosion proof electrical installation for combustible gases

Valve cabinet on the outside for easy handling

Heating

Lightning

Natural or forced air ventilation

Fire insulation or ordinary heat isolation

Gas detector

Roller conveyer

The complete container with all relevant equipment can be delivered ready for connection to the central gas pipe system.



Gas mixer.

A gas mixer can be an alternative to premixed gas for certain applications. Systems for two or three defined gases, designed for a variety of industrial applications with fluctuating gas consumption.

The mixer is one component in a turn key solution for centralized gas supply.

Our concept for on-site production of MISON[®] shielding gases or ODORO[®] odorized oxygen is a complete solution to customers with an existing cryogenic tank for argon or oxygen.

We design the system based upon the highest safety demands including our service SECCURA[®] automatic gas supply.

The most important process information for correct design are:

Type of application

Gas type

Yearly gas consumption in m³

Max. flow in m³ / hour

Pressure at point of use



Requirement of installations.

Engineering

Gas installations must be planned with according to pressure, type of gas, choice of materials and consumption. All relevant laws and regulations must be complied with. One of the most important is the Pressure Equipment Directive, abbreviated PED. The regulations relating to Equipment and Protective systems intended for use in Potentially Explosive Atmospheres, the ATEX directive, is also important.

There are also various standards for equipment, piping systems and welding procedures. Lind has a high level of expertise within design, planning and installation of central gas manifolds and we are a full-service supplier of complete gas systems. This entails that we deliver installations which operationally and in terms of safety are in accordance with the authorities' requirements.

Application to the authorities

The necessary applications and permits must be in order before a manifold is installed and becomes operational.

Risk analysis

There is a demand that the company make a total risk analysis of the gas installation and influence on other activities. Lind can help with more relevant information and experience. The risk analysis vary with the size and complexity of the manifold.

Installation

Installation of piping for gases requires both detailed knowledge of gases and expertise on pipe installations with qualifications in the joining method to be used.

Soldering and welding work on pressurized components must be performed by welders with qualifications in accordance with relevant standards.

Cleaning and degreasing

All equipment which is used must be free of dust, particles, dirt, filings, oil and grease, etc. which can create operating problems for the system. Pipe and components which will be used for oxygen must in addition be specially degreased to avoid ignition of organic material.

However, degreased pipe and components are recommended for all gases. Before installation, components and cleaned pipe must be especially protected against interior pollution using pipe plugs, bags or the like.

Pipework

Pipework shall be carried out in accordance with the piping plan, visible and with valves and other fittings easily accessible for operation and inspection.

Assembly

Before installation all pipes and components must be checked for cleanliness. Check also that their protection is intact.

Pipe assembly methods are:

1) Welded connections

The welding must be carried out in accordance with the specification prepared for welding. Welded connections must be welded right through. Welding of steel pipes should preferably be performed as TIG welding.

2) Brazing

Brazing is only permitted as capillary brazing when suitable soldering connections are used. Soldering must be performed with backside gas. Minimum 40 % silver content in filler material.

3) Tube fittings

Fittings should be reduced to a minimum and always be installed visible.

Compression fittings for the actual gas with double rings are the only acceptable and reliable fittings.

Blowing clean

The distribution network is blown clean with nitrogen, and this must be done without tapping points and other equipment being connected.

Pressure and leak testing

The distribution network is pressure tested with nitrogen.

This is carried out in accordance with established procedure.

Installation and final inspection

This is carried out in accordance with requirements for pressurized equipment. For most central gas installations, this may be carried out by an installation contractor, while for larger technical inspectorate is required.

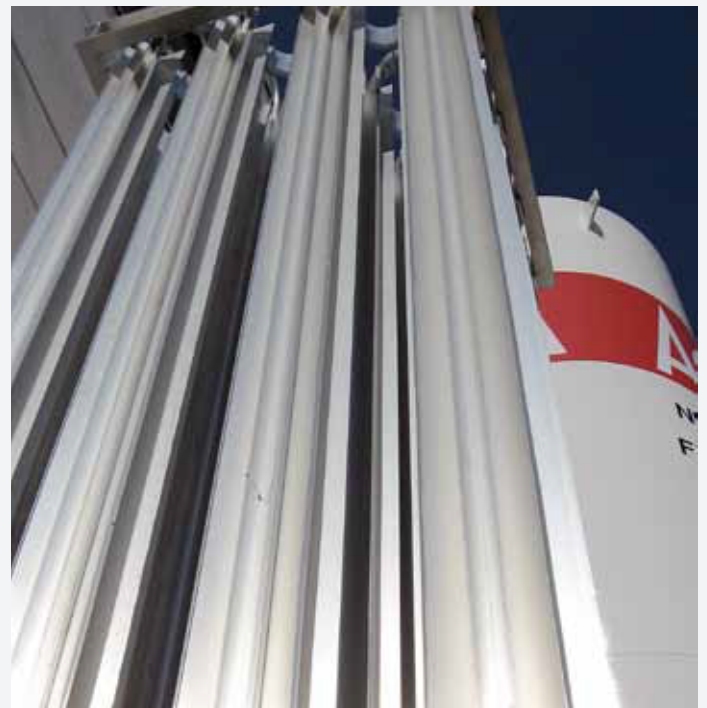

SECCURA® automatic gas supply.

Now you no longer need to worry about how much gas you have available!

SECCURA® automatic gas supply eliminates the possibility that the gas from cylinders or bundles unexpectedly runs out – in the middle of production. A sudden stoppage always entails problems which can involve production loss, increased costs and quality problems.

By means of the SECCURA® automatic gas supply, you do not need to think about how much gas you have left. An order is automatically sent directly to Linde. We see to it that new cylinders are installed without disturbing your production.

SECCURA® automatic gas supply removes the need to check, order and swap cylinders and cylinder bundles.

An electronic monitoring unit checks the amount of gas in the semiautomatic central gas manifold. When the gas level passes a preset minimum limit, an ordering signal is sent automatically to Linde via modem.

Linde receives the order.

The lorry carrying gas cylinders or cylinder bundles arrives within the pre-determined deadline.

The specially trained driver removes the empty gas cylinders or bundles and connects new ones.

Advantages of SECCURA® automatic gas supply:

- Increased operational reliability

- Time and cost reduction

- Fewer worries

- Increased safety



Service and maintenance.

Operational regularity is the best guarantee of profitable production and low costs.

A high safety level is required when handling gas. It is important that the process manifold functions flawlessly, both in consideration of personal safety, but also in consideration of operational reliability and the quality of the work which is carried out.

Regulatory requirements

The gas distribution system shall at all times fulfil regulatory requirements.

The system is often technically complicated and therefore requires up-to-date knowledge and experience in maintenance according to regulatory requirements.

With a service agreement from Linde you can always be sure that your gas manifold is maintained by specialists with extensive knowledge and expertise.

Operational regularity – the road to better economy

A shutdown can have large economic consequences.

Therefore it is important to improve operational regularity.

Leakage in the gas manifold and regulators can be very costly. Leakage means increased costs and reduced gas capacity. If air enters the manifold as a consequence of leakage, it can influence the process negatively. Therefore, continuous monitoring and systematic maintenance is required to improve regularity of service and ensure that the gas manifold functions optimally.

We follow set procedures for what is to be checked, and the service report gives you documentation that the gas manifold has been checked. Through preventative service and maintenance, you get a central gas manifold which will last.



Cylinder gas manifold.

SIMPLEXcylinder gas manifold.

The SIMPLEXtype of central gas manifold is used where gas consumption is relatively low and where operational or safety-related advantages can be achieved by installing a central gas manifold. Examples of such consumers are small mechanical workshops, schools, and so on. The gas cylinders are connected to a manifold by high pressure hoses.

Between each high-pressure hose and the manifold there is a shut-off valve, which makes it possible to empty the gas cylinders one by one. A contact gauge and alarm can be connected to the central gas manifold. The unit can be set so that a signal is given when a certain cylinder pressure is reached. SIMPLEXare available for up to 4 cylinders. The central regulator MR-21 has an evacuation pipe from the relief valve. This pipe must be run to the outdoors.

The manifold is delivered with a CE market safety valve which should be connected to an evacuation pipe.

The ball valve after the safety valve functions as a service valve.

Standard SIMPLEXcan be used for the following gases:

Acetylene, oxygen, argon, MISON[®], nitrogen, helium, hydrogen, carbon dioxide. SIMPLEXfor acetylene are delivered with a manual quick acting shut-off valve, which is installed before the pressure regulator. The valve ensures quick shut off against dangerous decomposition of acetylene in the high pressure parts of the manifold. A flame arrester should in addition be installed directly after the manifold for protection of the cylinders. According to EN ISO 14114 and EN - ISO 15615.

Other gases on inquiry.

Specifications:

- Inlet pressure 200 bar
- Inlet pressure, acetylene 20 bar
- Max. outlet pressure 10 bar
- Max. outlet pressure, acetylene 1.1 bar
- Pipe weld adapter \varnothing 15.2 x 2.6 mm stainless steel EN 1.4301 on outlet
- Min. temp. - 20° C

Opening pressure safety valve :

- Oxygen + inert gases 18 bar
- Acetylene 1,5 bar

For gases other than oxygen, these factors must be used to calculate the regulator capacity:

Hydrogen	4.01
Helium	2.84
Argon	0.90
Nitrogen	1.08
Carbon dioxide	0.85

Gas flow = oxygen x factor = m³ / h

Supplementary equipment:

- Alarm
- Contact gauge
- Sign
- Flame arrester for flammable gases



Capacity curves - Acetylene

Inlet pressure $P_1 = \text{bar}$

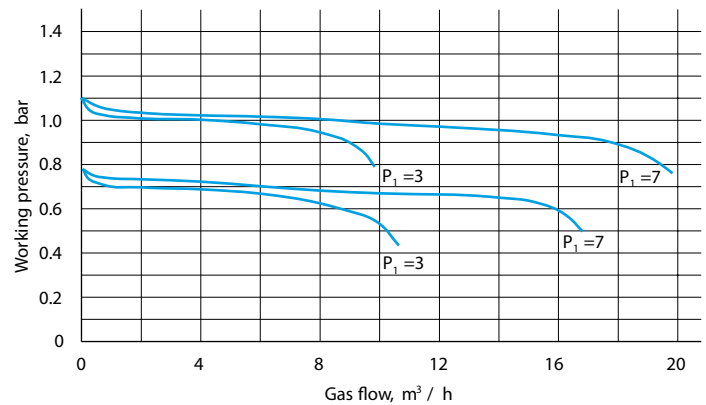

Capacity curves - Oxygen

Inlet pressure $P_1 = \text{bar}$

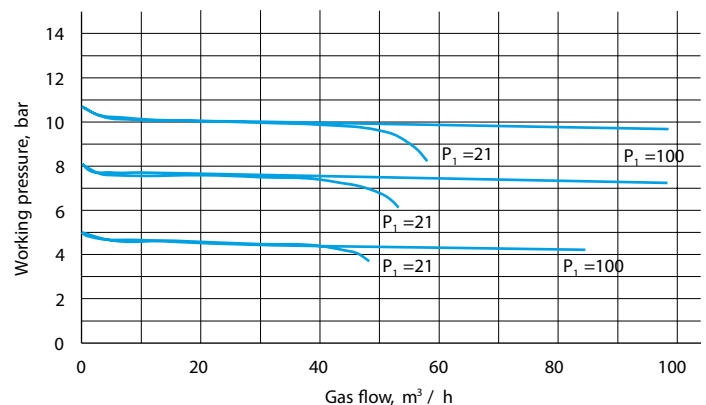

SIMPLEX cylinder gas manifold

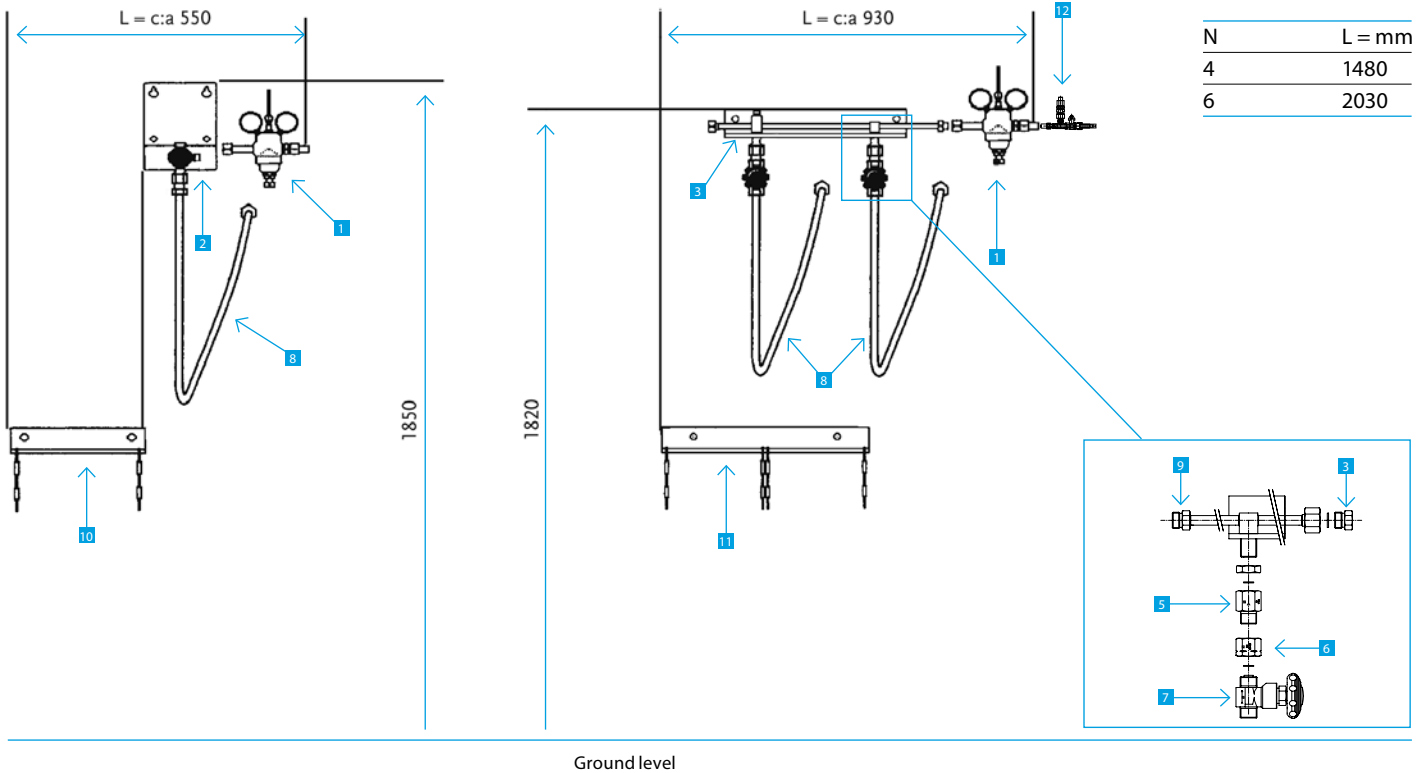

Pos	Components	Non-combustible gases Article no.	Combustible gases Article no.
1	Regulator MR 21	See page 24	See page 24*)
2	Valve module Components: Valve module acetylene inclusive R21	301986 (203 010 662)	301985 (203 010 663) 330255 (9624120) *)
3	Manifold 2 cylinders	301963 (215 191 072)	301962 (215 191 070)
4	Alternative manifold 4 cylinders	301967 (215 191 073)	301965 (215 191 071)
5	Non-return valve	301849 (215 191 044)	301979 (215 191 043)
6	Nut	301636 (200 059 835)	301636 (200 059 835)
7	Valve DN3	301632 (203 010 424)	301953 (203 010 633)
8	High pressure hose	See page 28	See page 28
9	Cap	301958 (215 191 077)	301949 (215 191 076)
10	Anchor beam 1 cylinder	301937 (215 191 074)	301937 (215 191 074)
11	Alternative anchor beam 2 cylinders	301957 (215 191 075)	301957 (215 191 075)
12	Safety valve kit oxygen	330487 (9626400)	
12	Safety valve kit acetylene		330489 (9626510)
13	Blank	301958 (215 191 077)	301949 (215 191 076)
	Wrench NV30	303814 (201 301 046)	303814 (201 301 046)
	Aluminium gaskets	301523 (200 065 522)	301523 (200 065 522)

*) Special design for acetylene manifolds with manual shut - off device. Valve unit and regulator are delivered as one unit.

Complete gas manifold

Description	Acetylene	Argon - MISON® Nitrogen - Helium	Hydrogen FORMIER	Oxygen Carbon dioxide
	Article no.	Article no.	Article no.	Article no.
SIMPLEX1	330270 (851 001 110)	330297 (851 001 710)	330321 (851 001 310)	330315 (851 001 020)
SIMPLEX2	330271 (851 001 111)	330323 (851 001 711)	330319 (851 001 311)	330313 (851 001 021)
SIMPLEX4	330300 (851 001 112)	330325 (851 001 712)	330317 (851 001 312)	330312 (851 001 022)

* High pressure hoses 1 m included as standard.

Cylinder gas manifold.

DUPLEXcylinder gas manifold.

DUPLEXare normally used where there is need for a stable gas flow. This central gas manifold is split in two groups, where the one group functions as the operations side and the other is the reserve when the operations side is emptied. Which side is to be operative and which is the reserve will alternate. All cylinders in one side should be emptied simultaneously. Changeover to the other side is done manually. The central gas manifold can be equipped with a contact gauge and alarm to monitor when empty cylinders need to be changed. The gas cylinders are connected to the manifold by high pressure hoses. Between each high-pressure hose and the manifold there is a shut-off valve. DUPLEXare available for 2+2 or 4+4 cylinders. The central regulator MR-21 is delivered with a relief valve, which should be connected to an evacuation pipe. The manifold is delivered with a CE market safety valve which should be connected to an evacuation pipe.

The ball valve after the safety valve functions as service valve.

Standard DUPLEXcan be used for the following gases:

Acetylene, oxygen, argon, MISON, nitrogen, helium, air, hydrogen, carbon dioxide.

DUPLEXfor cylinders with acetylene are delivered with a manual quick acting shut-off valve, which is installed before the pressure regulator. The valve ensures quick shut off against dangerous decomposition of acetylene in the high pressure parts of the manifold. A flame arrestor should in addition be installed direct after the manifold for protection of the cylinders. Accordance to EN ISO 14114 and EN - ISO 15615.

Other gases on inquiry.

Specifications:

- Inlet pressure 200 bar
- Inlet pressure, acetylene 20 bar
- Max. outlet pressure 10 bar
- Max. outlet pressure, acetylene 1,1 bar
- Pipe weld adapter \varnothing 15,2 x 2.6 mm of stainless steel, EN 1.4301 on outlet
- Min. temp. - 20° C

Opening pressure safety valve:

- Oxygen + inert gases 18 bar
- Acetylene 1,5 bar

For gases other than oxygen, these factors must be used to calculate the regulator capacity:

Hydrogen	4.01
Helium	2.84
Argon	0.90
Nitrogen	1.08
Carbon dioxide	0.85

Gas flow = oxygen x factor = m^3 / h

Supplementary equipment :

- Alarm
- Contact gauge
- Sign
- Flame arrestor for flammable gases



Capacity curves - Acetylene

Inlet pressure $P_1 = \text{bar}$

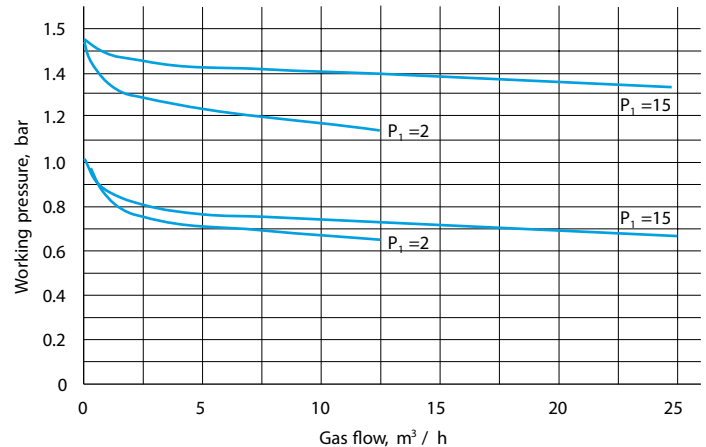

Capacity curves - Oxygen

Inlet pressure $P_1 = \text{bar}$

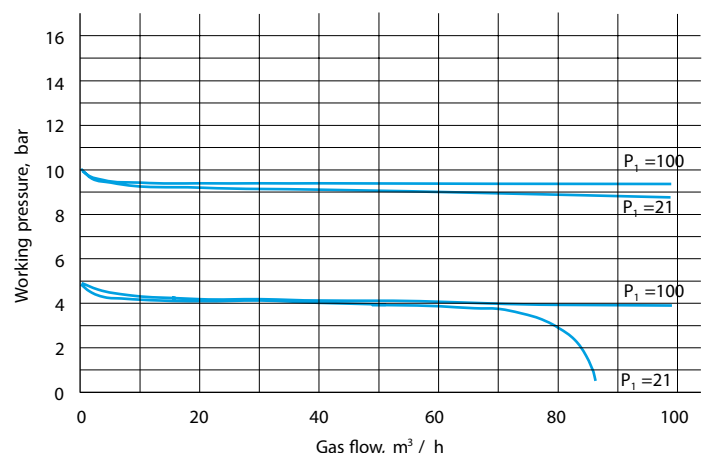

DUPLEX cylinder gas manifold

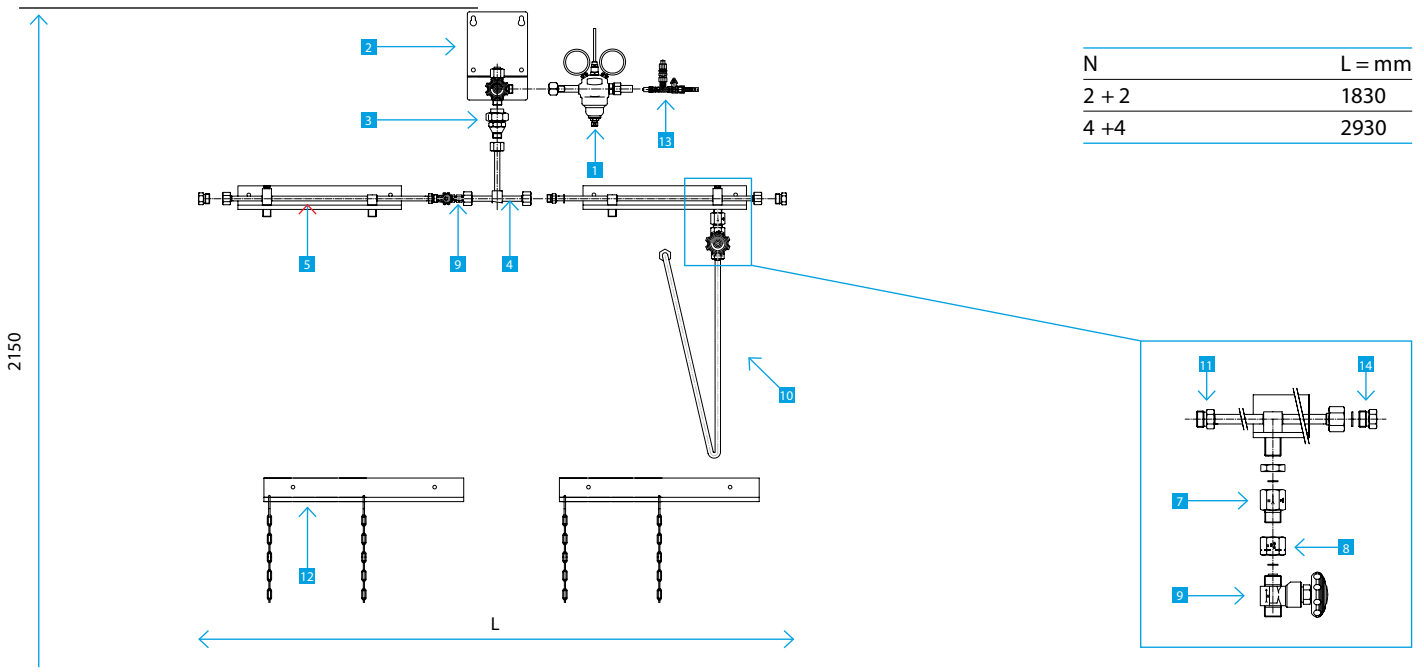

N	L = mm
2 + 2	1830
4 + 4	2930

Pos	Components	Non-combustible gases	Combustible gases
		Article no.	Article no.
1	Regulator MR 21	See page 24	See page 24 *)
2	Valve module	301986 (203 010 662)	301985 (203 010 663)
	Components:		
	Valvemoduleacetylene inclusive MR21		330255 (9624120) *)
3	High pressure filter	301613 (215 190 042)	301956 (215 191 086)
4	T-pipe	301932 (215 191 085)	301931 (215 191 084)
5	Manifold 2 cylinders	301963 (215 191 072)	301962 (215 191 070)
6	Alternative manifold 4 cylinders	301967 (215 191 073)	301965 (215 191 071)
7	Non-return valve	301849 (215 191 044)	301979 (215 191 043)
8	Nut	301636 (200 059 835)	301636 (200 059 835)
9	Valve DN3	301632 (203 010 424)	301953 (203 010 633)
10	High pressure hose	See page 28	See page 28
11	Blind nut	301966 (215 191 080)	301959 (215 191 081)
12	Anchor beam 2 cylinders	301957 (215 191 075)	301957 (215 191 075)
13	Safety valve kit oxygen	330487 (9626400)	
13	Safety valve kit acetylene		330489 (9626510)
14	Blank	301958 (215 191 077)	301949 (215 191 076)
	Wrench NV30	303814 (201 301 046)	303814 (201 301 046)
	Aluminiumgaskets	301523 (200 065 522)	301523 (200 065 522)

*) Special design for acetylene manifolds with manual shut - off device. Valve unit and regulator are delivered as one unit.

Complete gas manifold

Description	Acetylene	Argon - MISON® Nitrogen - Helium	Hydrogen FORMIER	Oxygen Carbon dioxide
	Article no.	Article no.	Article no.	Article no.
DUPLEX				
2 + 2 cylinders	330272 (851 002 101)	330266 (851 002 701)	330326 (851 002 301)	330264 (851 002 001)
DUPLEX4				
4 + 4 cylinders	330273 (851 002 102)	330265 (851 002 702)	330328 (851 002 302)	330261 (851 002 002)

* High pressure hoses 1 m included as standard.

Bundle gas manifold.

DUPLEXbundle gas manifold.

The DUPLEXbundle gas manifold is used when there is a continuous high demand for gas. The central gas manifold is divided in two parts, where the one is in operation and the other is in reserve. Which side is to be operative and which is the reserve will alternate. All cylinders in the bundle are emptied simultaneously. Changeover is done manually. The central bundle manifold can be equipped with a contact gauge to monitor when the changeover is necessary. The gas bundles are connected to the manifold by high-pressure hoses. Between each high-pressure hose and the manifold there is a shut-off valve. DUPLEX are available for 1+1 or 2+2-bundles. The central regulator MR-60 is delivered with a CE market safety valve, which should be connected to an evacuation pipe.

Standard DUPLEX can be used for the following gases:

Acetylene, oxygen, argon, MISON[®], helium, nitrogen, hydrogen and carbondioxide.

DUPLEX for bundles with acetylene are delivered with an automatic quick acting shut-off valve, which is installed before the pressure regulator. The valve ensure automatic shut off against dangerous decomposition of acetylene in the high pressure part of the manifold. A flame arrestor should in addition be installed direct after the manifold for protection of the cylinders. Accordance to EN ISO 14114 and EN - ISO 15615.

Other gases on inquiry.

Specifications:

- Inlet pressure 200 bar
- Inlet pressure, acetylene 20 bar
- Max. outlet pressure 12 bar
- Max. outlet pressure, acetylene 1,1 bar
- Pipe weld adapter Ø 23. 7 x 2.8 mm of stainless steel, EN 1.4301 on outlet
- Min. temp. - 20° C

Opening pressure safety valve

- Oxygen + inert gases 18 bar
- Acetylene 1,5 bar

Supplementary equipment :

- Alarm
- Contact gauge
- Signs
- Flame arrestor for flammable gases
- Main shut-off valve after manifold

For gases other than oxygen, these factors must be used to calculate the regulator capacity:

Hydrogen	4.01
Helium	2.84
Argon	0.90
Nitrogen	1.08
Carbondioxide	0.85

Gas flow = oxygen x factor = m³ / h



Capacity curves - Acetylene

Inlet pressure $P_1 = \text{bar}$

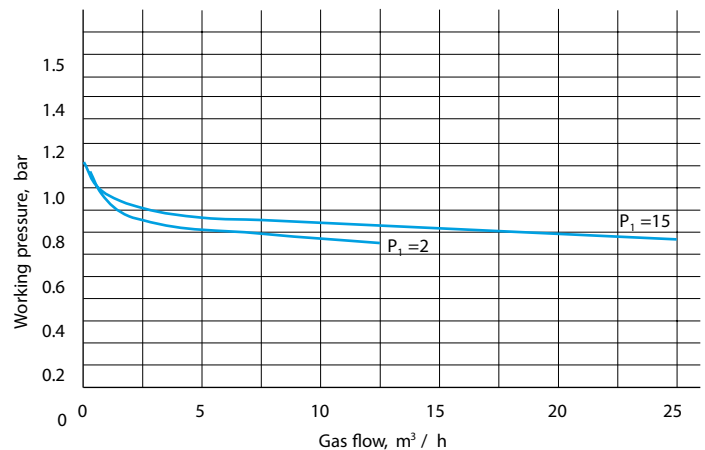

Capacity curves - Oxygen

Inlet pressure $P_1 = \text{bar}$

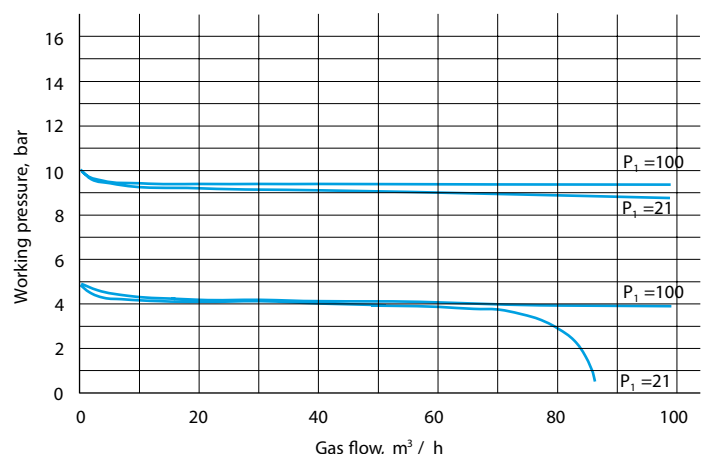

DUPLEX bundle gas manifold

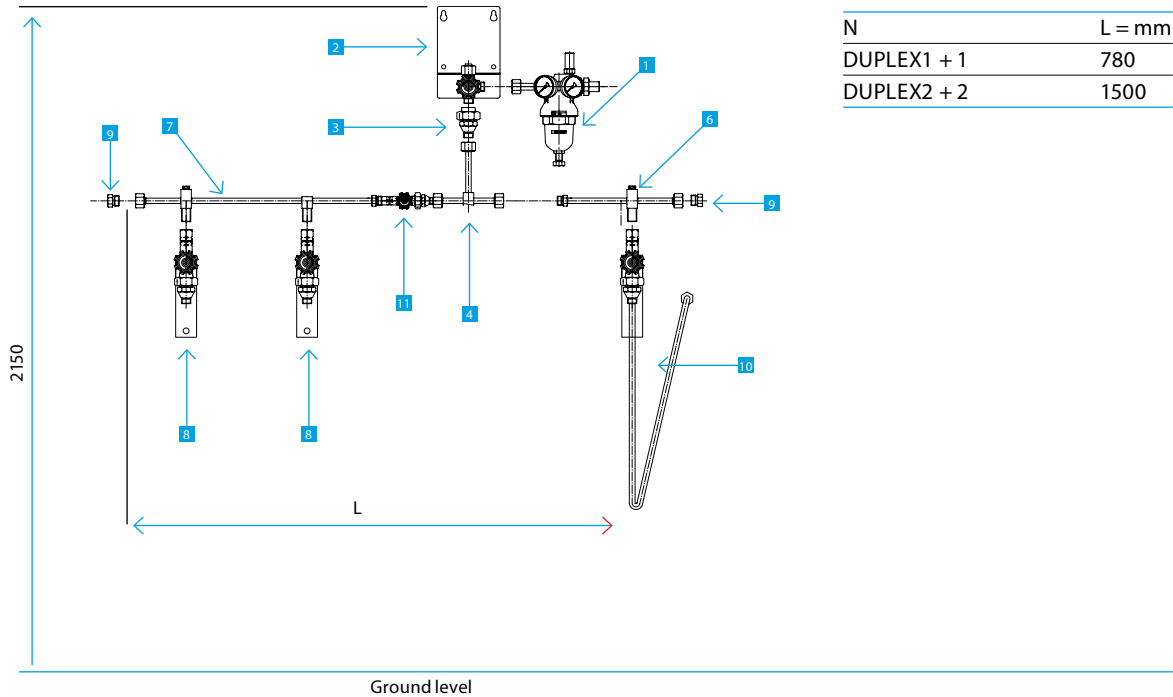

Pos	Components	Non-combustible gases	Combustible gases
		Article no.	Article no.
1	Regulator MR 60	See page 25	See page 25 *)
2	Valve module		301852 (850 003 300 *)
	Valve module acetylene inklusive MR 60		330256 (9624130)
3	High pressure filter	301613 (215 190 042)	301956 (215 191 086)
4	T-pipe	301932 (215 191 085)	301931 (215 191 084)
6	Manifold tube 1 bundle	301877 (215 191 012)	301990 (215 191 007)
7	Alternative manifold tube 2 bundles	301981 (215 191 013)	301989 (215 191 008)
8	Valve DN6 with bracket	301631 (215 190 217)	303627 (215 191 087)
9	Blind nut (for 2+2 bundles)	301966 (215 191 080)	301959 (215 191 081)
9	Cap (for 1+1 bundle)	301958 (215 191 077)	301949 (215 191 076)
10	High pressure hose, 2 M length	See page 28	See page 28
11	Valve DN6	301634 (203 010 533)	301955 (203010660)
	Wrench NV30	303814 (201 301 046)	303814 (201 301 046)
	Aluminiumgaskets	301523 (200 065 522)	301523 (200 065 522)

*) Special design for acetylene manifolds with automatic shut - off device. Valve unit and regulator are delivered as one unit. Art. no. 9624120.

Complete central gas manifold for 1 or 2 gas bundles on each side

Description	Acetylene	Argon - MISON® Nitrogen - Helium	Hydrogen FORMIER	Oxygen Carbon dioxide
	Article no.	Article no.	Article no.	Article no.
DUPLEX 1 + 1 bundles	330274 (851 002 104)	301925 (850 002 704)	301921 (850 002 304)	301907 (850 002 004)
DUPLEX 2 + 2 bundles	330275 (851 002 105)	301924 (850 002 705)	301920 (850 002 305)	301893 (850 002 005)

* High pressure hoses 2 m included as standard.

Cylinder gas manifold.

BMD 100 - 39S semi-automatic cylinder gas manifold.

The semi-automatic cylinder gas manifold is intended for low or mid-range consumption and continuous gas supply without interruption when changing cylinders. All cylinders in the group are emptied simultaneously. Two sets of cylinders are connected to the central gas manifold.

One side functions as the operational side, while the other is held in reserve until the operational side is empty. Changeover itself happens automatically.

All cylinders on the same side should be emptied simultaneously. The semi-automatic central gas manifold is also available with a contact gauge. An alarm system which can be connected, triggers an alarm when there is a changeover from the operational side to the reserve side. The central regulator of type Unicontrol 500 are delivered with CE market safety valves, which should be connected to an evacuation pipe.

Standard BMD - 100 - 39S can be used for the following non-combustible gases:

Oxygen, argon, MISON[®], helium, nitrogen and carbon dioxide.

The standard manifold is delivered according to the table on next page. Other gases on inquiry.

Specifications:

Inlet pressure 200 bar

Max. outlet pressure 16 bar

Weight panel 13.8 kg

Inlet connection panel W 21.8 x 1/14" RH

Pipe weld adapter Ø 21.2 mm stainless steel EN 1.4301 on outlet

Min. temp. - 20° C

The operational side is pre-set at approximately 15 bar and the reserve side is pre-set at approximately 11 bar

Opening pressure safety valve 18 bar

Supplementary equipment:

Alarm

Contact gauge

Signs



Capacity curves - Oxygen

Inlet pressure $P_1 = \text{bar}$

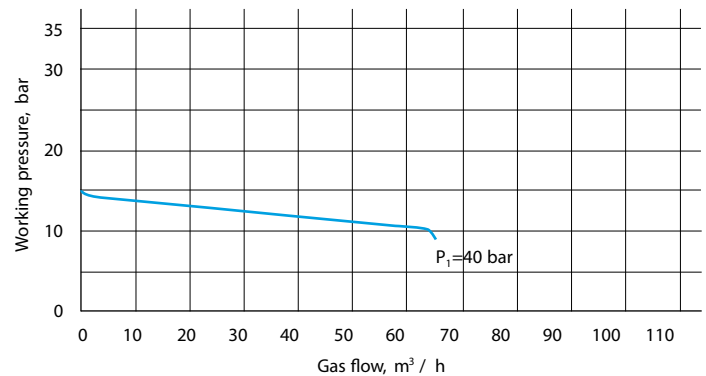

For gases other than oxygen, these factors must be used to calculate the regulator capacity:

Helium	2.84
Argon	0.90
Nitrogen	1.08
Carbon dioxide	0.85

Gas flow = oxygen x factor = m³ / h

BMD 100 - 39S semi-automatic cylinder gas manifold

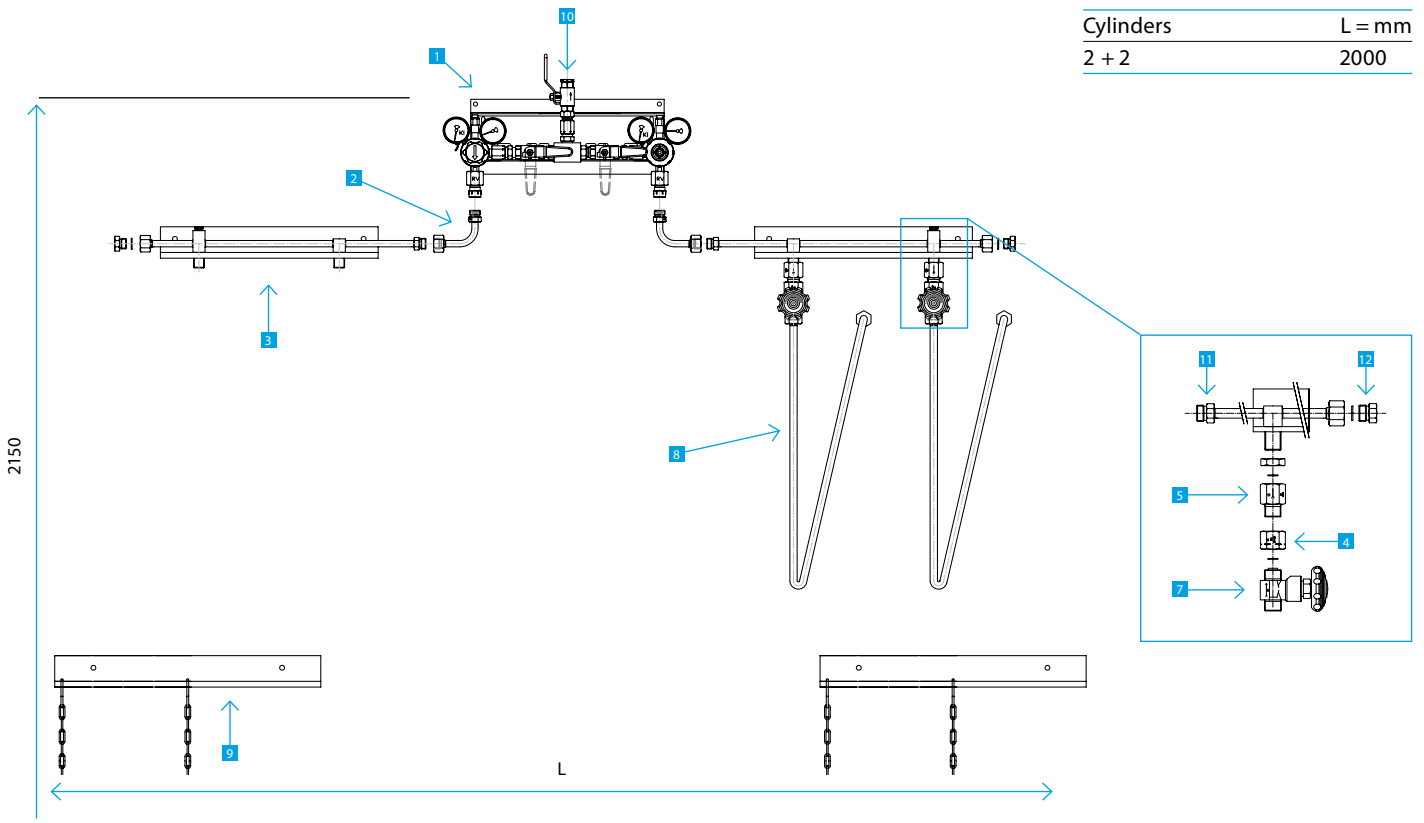

Cylinders	L = mm
2 + 2	2000

Pos	Components	Non-combustible gases Article no.
1	Valve unit BMD 100 - 39S	330179 (768 079)
2	Elbow	301954 (215 191 010)
3	Manifold tube 2 cylinders	301963 (215 191 072)
4	Nut	301966 (215 191 080)
5	Non-return valve	301849 (215 191 044)
6	Nut, right-left	301636 (200 059 835)
7	High pressure valve DN3	301632 (203 010 424)
8	High pressure hose 1M	See page 28
9	Anchor beam, 2 cylinders	301957 (215 191 075)
10	Safety valve kit	330487 (9626400)
11	Blank	301958 (215 191 077) 301949 (215 191 076)
12	Blind nut	301966 (215 191 080) 301959 (215 191 081)
	Wrench NV30	303814 (201 301 046)
	Aluminiumgaskets	301523 (200 065 522)

Complete gas manifold for cylinders

Description	Argon - MISON [*]	Oxygen
	Nitrogen - Helium	/ Carbondioxide
	Article no.	Article no.
BMD 100 - 39S		
2 + 2 cylinders	316735 (316 735)	316736 (316 736)

* High pressure hoses 1 m included as standard.

Bundle gas manifold.

MIC - 60 semi-automatic bundle gas manifold.

The semi-automatic bundle gas manifold is intended for large consumption, or for situations where it is desirable to ensure continuous gas supply with no interruption when exchanging cylinders.

Two sets of bundles are connected to the central gas manifold. One side functions as the operational side, while the other is held in reserve until the operational side is empty. Changeover itself happens automatically. Bundles on the same side are emptied simultaneously. A contact gauge and alarm can be connected to the semi-automatic manifold. An alarm system triggers an alarm when there is a changeover from the operational side to the reserve side.

The central regulators MR-60 are delivered with CE market safety valves, which should be connected to an evacuation pipe.

The MIC 60 is available for the following gases:

acetylene, argon, MISON, nitrogen, helium, hydrogen, carbon dioxide and oxygen.

MIC 60 for bundles with acetylene are delivered with two automatic quick acting shut-off valves, which are installed before the pressure regulators.

The valve ensures automatic shut off against dangerous decomposition of acetylene in the high pressure part of the manifold. A flame arrester should in addition be installed direct after the manifold for protection of the cylinders. According to EN ISO 14114 and EN - ISO 15615.

Other gases on inquiry.

Specifications:

Inlet pressure 200 bar

Inlet pressure, acetylene 20 bar

Inlet threads panel, non-combustible gases W 21.8 x 1/14" ext right-threaded

Inlet threads panel, combustible gases W 21.8 x 1/14" ext left-threaded

Pipe weld adapter Ø 21.2 x 3.1 mm EN 1.4301 stainless steel on outlet

Panel weight 24 kg

Min. temp. - 20° C

For compressed gases the outlet pressure is set at approximately 10 bar in operational side and 9 bar on the reserve side.

For acetylene the outlet pressure is set at approximately 1,1 bar on the operational side and 0,8 bar on the reserve side.

Opening pressure safety valve

Oxygen + inert gases 18 bar

Acetylene 1,5 bar

For gases other than oxygen, these factors must be used to calculate the regulator capacity:

Hydrogen	4.01
Helium	2.84
Argon	0.90
Nitrogen	1.08
Air	1.05
Carbondioxide	0.85

Gas flow = oxygen x factor = m³ / h

Optional accessories:

Alarm

Contact gauge

Signs

Flame arrester for flammable gases

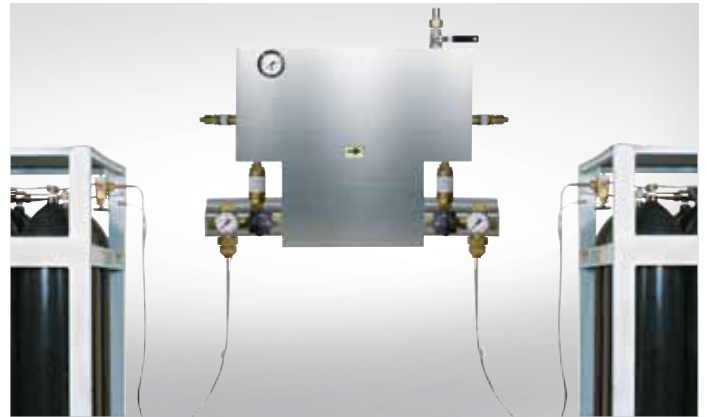

Capacity curves - Oxygen

Inlet pressure $P_1 = \text{bar}$

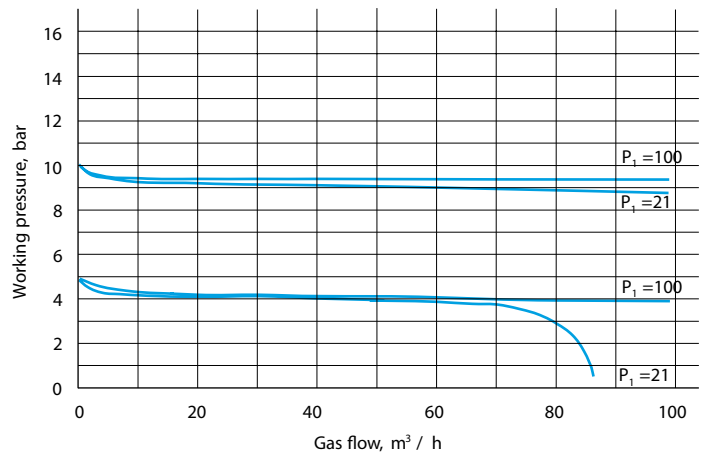

Capacity curves - Acetylene

Inlet pressure $P_1 = \text{bar}$

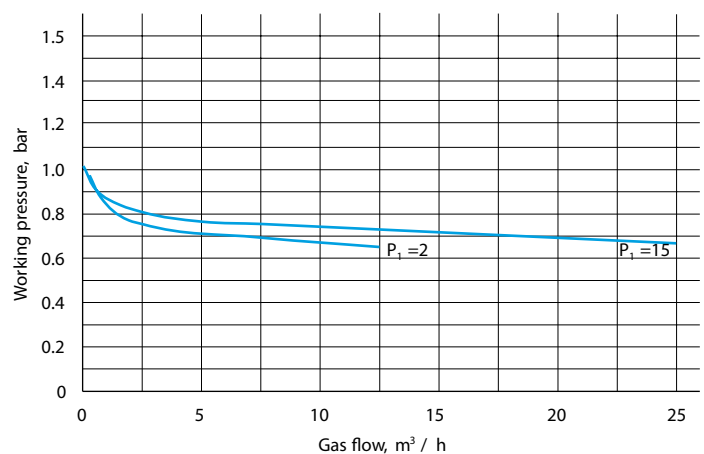

MIC - 60 semi-automatic bundle gas manifold

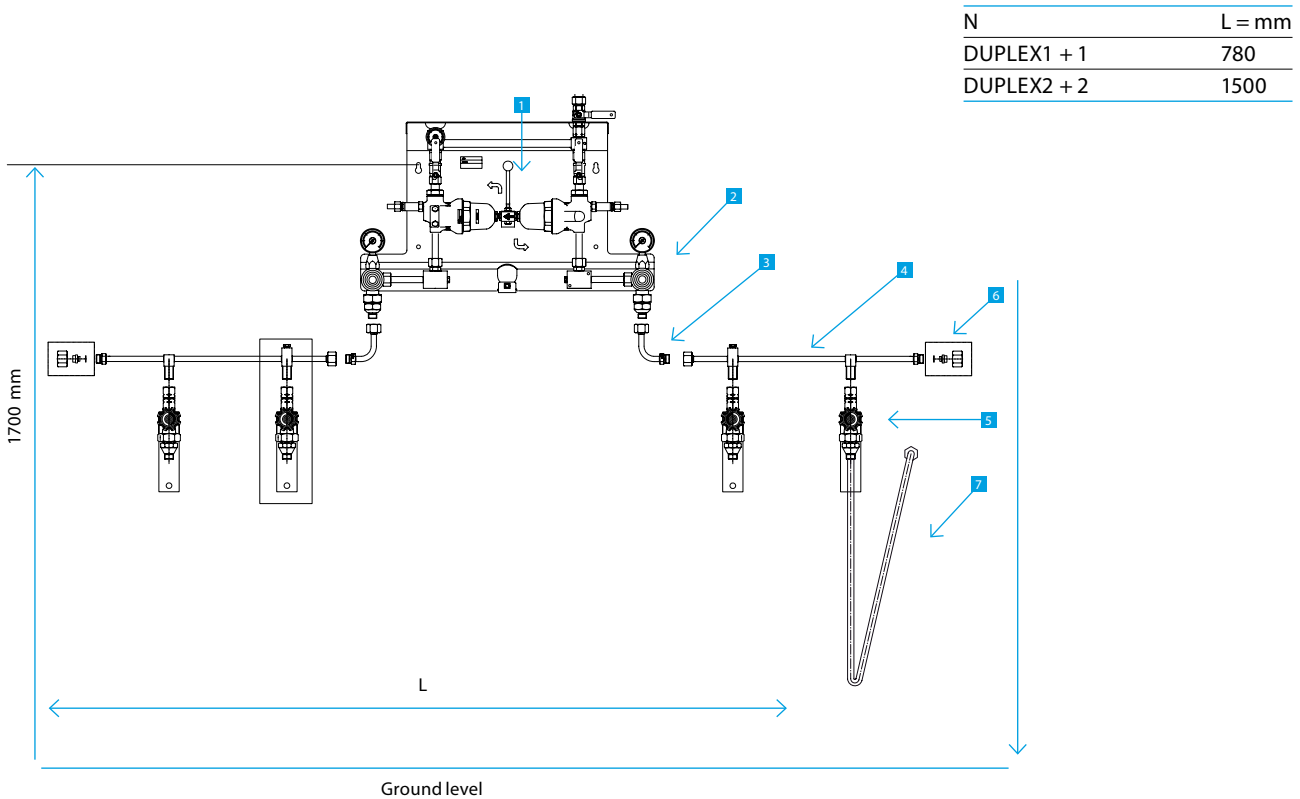

Pos	Components	Non-combustible gases Article no.	Combustible gases Article no.
1	Valve unit oxygen	330221 (0768 080)	
1	Valve unit hydrogen		330222 (0768 081)
1	Valve unit argon	330224 (0768 078)	
1	Valve unit acetylene		330257 (0768 082)
2	High pressure filter	301613 (215 190 042)	301956 (215 191 086)
3	Elbow	301954 (215 191 010)	301950 (215 191 005)
4	Manifold tube 2 bundles	301981 (215 191 013)	301989 (215 191 008)
5	Valve DN6 with bracket	301631 (215 190 217)	303627 (215 191 087)
6	Blind nut	301966 (215 191 080)	301959 (215 191 081)
7	High pressure hose, 2 M length	See page 28	See page 28
	Wrench NV30	303814 (201 301 046)	303814 (201 301 046)
	Aluminiumgaskets	301523 (200 065 522)	301523 (200 065 522)

Complete gas manifold for gas cylinders

Description	Acetylene	Argon - MISON [®] Nitrogen - Helium	Hydrogen FORMIER	Oxygen Carbondioxide
	Article no.	Article no.	Article no.	Article no.
MIC 60 1 + 1 bundle	330278 (851 003 103)	301850 (850 003 703)	301874 (850 003 303)	301868 (850 003 003)
MIC 60 2 + 2 bundles	330267 (851 003 104)	301843 (850 003 704)	301872 (850 003 304)	301867 (850 003 004)

* High pressure hoses 2 meter included as standard.

Automatic bundle gas manifold.

AUTOFILL automatic bundle gas manifold.

AUTOFILL automatic bundle gas manifold

AUTOFILL is a semi-automatic bundle gas manifold for oxygen, nitrogen, argon and argon-mixtures. It provides a continuous gas supply to tapping points through a permanently installed distribution network.

AUTOFILL is supplied from a gas bundle and has two gas cylinders in reserve. The reserve cylinders automatically take over gas delivery when the gas bundle is empty.

When changing over to a new gas bundle, the reserve cylinders will automatically be filled up from the full bundle and therefore cylinders with residual gas valve can not be used.

It is the gas bundle that is exchanged. The cylinders on the reserve side must remain permanently connected. AUTOFILL can be fitted with a contact gauge for registering when the bundle is empty.

AUTOFILL provides economic and reliable gas delivery by reducing the number of cylinders on the reserve side to two. However, the reserve side will be emptied faster than in an ordinary two-sided central bundle manifolds.

The central regulators MR-60 are delivered with CE market safety valves, which should be connected to an evacuation pipe.

Specifications:

- Inlet pressure 200 bar
- Inlet threads panel, W 21. 8 x 1/14" RH
- Pipe weld adapter \varnothing 21.2 x 3.1 mm of stainless steel
- EN 1.4301 on outlet
- Panel weight 24 kg
- Min. temp. - 20° C
- The outlet pressure is set at approximately 10 bar in operational side and 8 bar on reserve side.

Opening pressure safety valve
Oxygen + inert gases 18 bar

Optional accessories:

- Alarm
- Contact gauge
- Signs



Capacity curves - Oxygen

Inlet pressure $P_1 = \text{bar}$

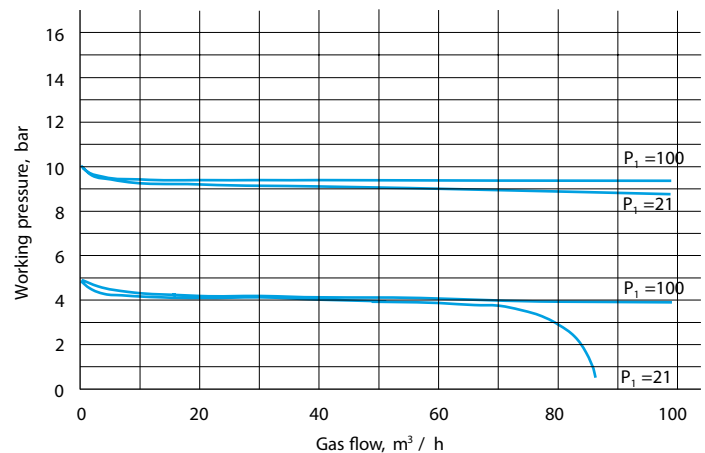

For gases other than oxygen, these factors must be used to calculate the regulator capacity:

Helium	2.84
Argon	0.90
Nitrogen	1.08

Gas flow = oxygen x factor = m³ / h

AUTOFILL automatic bundle gas manifold

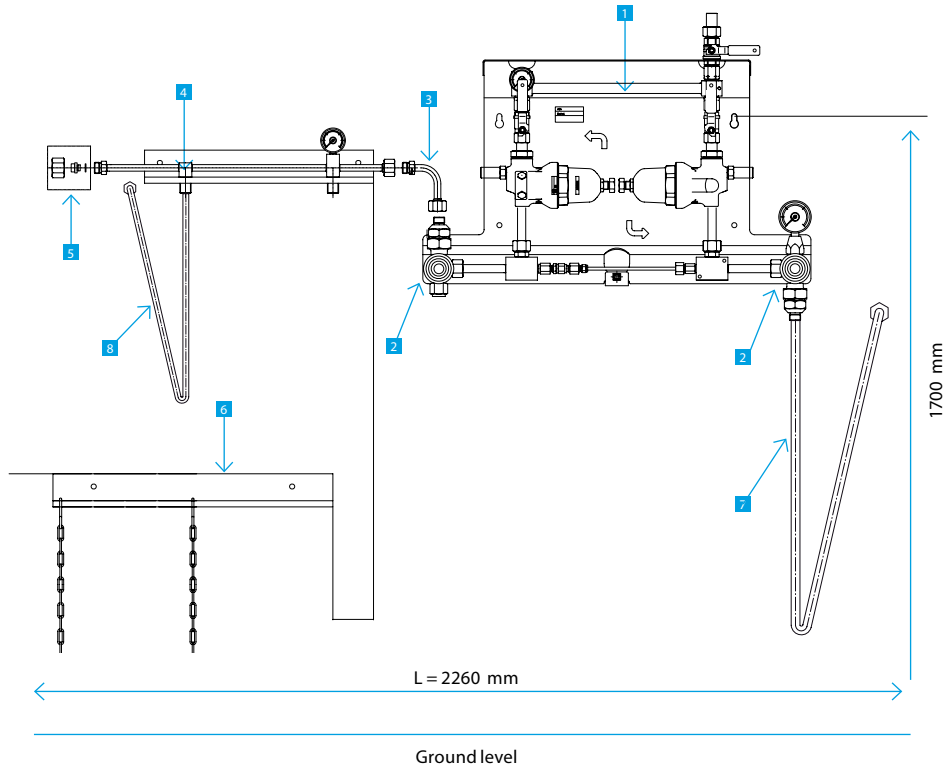

Pos	Components	Non-combustible gases Article no.
1	Valve unit AUTOFILL,Oxygen	330223 (768083)
1	Valve unit AUTOFILL,Argon	330178 (768084)
2	High pressure filter	301613 (215 190 042)
3	Elbow	301954 (215 191 010)
4	Manifold tube 2 cylinders	301963 (215 191 072)
5	Blind nut	301966 (215 191 080)
6	Anchor beam, 2 cylinders	301957 (215 191 075)
7	High pressure hose, 2 M length	See page 31
8	High pressure hose, 1 M length	See page 31
	Wrench NV30	303814 (201 301 046)
	Aluminiumgasket	301523 (200 065 522)

Complete gas manifold for bundles

Description	Argon - MISON [®]	Oxygen
	Nitrogen - Helium	
Article no.	Article no.	Article no.
AUTOFILL 2 cylinders + 1 bundle	301882 (850 005 001)	301866 (850 005 701)

* One high pressure hose of 2 meters length and two of 1 meters length are included

Manyflow.

MANYFLOWs a compact, flexible high pressure valve unit. It is easily rigged up and excellent for temporary installations or where there is limited space.

MANYFLOWs intended for maximum 3 cylinders. All inlets on the valve unit are equipped with a non-return valve.

The MANYFLOW valve unit is supplemented by other equipment to complete the central gas unit. This comprises the central regulator, high pressure hoses and anchor beams. See table. The central regulator type MR21 has an evacuation pipe from the relief valve, which should be connected to an evacuation pipe.

Specifications:

- Inlet pressure 200 bar
- Inlet pressure, acetylene 20 bar
- Max. outlet pressure oxygen 10 bar
- Max. outlet pressure, acetylene 1.5 bar
- Inlet threads valve unit oxygen W 21. 8 x 1/14" RH
- Inlet threads valve unit acetylene W 21. 8 x 1/14" LH
- Pipe weld adapter Ø 15.2 x 2.6 mm of stainless steel EN 1.4301 on outlet
- Min. temp. - 20° C

Other optional accessories:

- Signs
- Flame arrester for flammable gases
- Safety valve for installation on piping
- Main shut off valve after manifold



Component list for ordering	Oxygen	Acetylene
	Article no.	Article no.
Valve unit manyflow	316740 (850 001 031)	
Regulator MR 21	301989 (215 191 093)	
Valve module inclusive MR21		330255 (9624120)
High pressure hose 1M, 1 PC.	301945 (215 191 024)	301943 (215 191 021)
High pressure hose 2M, 2 PCS.	301946 (215 191 025)	301944 (215 191 022)
Anchor beam 1 cylinder	301937 (215 191 074)	301937 (215 191 074)
Anchor beam 2 cylinders	301957 (215 191 075)	301957 (215 191 075)
Aluminium gaskets	301523 (200 065 522)	301523 (200 065 522)
Safety valve kit	330487 (9626400)	330489 (9626510)
Wrench NV30	303814 (201 301 046)	303814 (201 301 046)

Can also be used for non-combustible gases other than oxygen. The central regulator and high pressure hoses must then be changed.

Capacity curves - Acetylene

Inlet pressure $P_1 = \text{bar}$

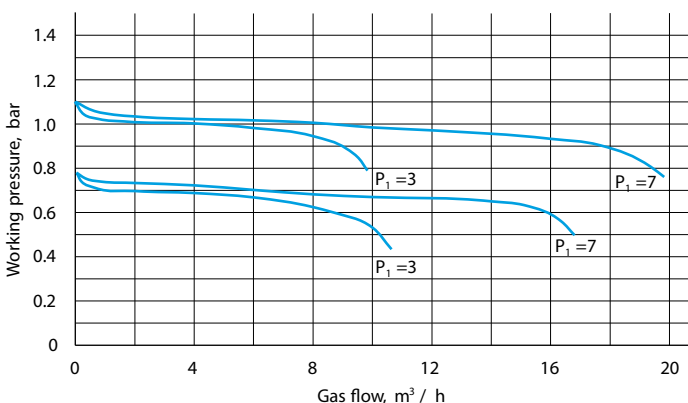

Capacity curves - Oxygen

Inlet pressure $P_1 = \text{bar}$

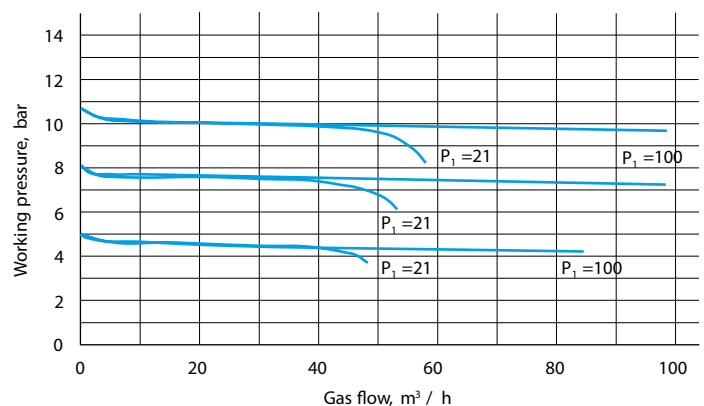

Central regulator MR - 21.

MR - 21 is included as standard in the SIMPLEX and DUPLEX cylinder gas manifold.

The regulator has robust construction with very fine control and has significantly greater capacity than ordinary, comparable regulators. MR - 21 is delivered with an evacuation pipe from the relief valve. The pipe must run to the outdoors. The evacuation pipe is made of stainless steel EN 1.4301, Ø 6 x 1 mm.

The regulator is delivered with pipe welding adapter of stainless steel; EN 1.4301, Ø 15.2 x 2.6 mm on outlet.

Combustible gases:

Inlet coupling W 21.8 x 1/14" LH

Non-combustible gases:

Inlet coupling W 21.8 x 1/14" RH



Gas	Inlet Pressure	Max. Outlet Pressure	Safety function	Relief valve, set pressure	Article no.
Acetylene	20 BAR	1,1 BAR	RELIEFVALVE	1,7 - 2,2 BAR	301977 (215 191 090)
Hydrogen	200 BAR	10 BAR	RELIEFVALVE	11 - 14 BAR	301969 (215 191 092)
Oxygen	200 BAR	10 BAR	RELIEFVALVE	11 - 14 BAR	301987 (215 191 093)
Argon	200 BAR	10 BAR	RELIEFVALVE	11 - 14 BAR	307937 (215 191 115)
Propane	18 BAR	4 BAR	RELIEFVALVE	4,5 - 5,5 BAR	303618 (215 191 091)

Capacity curves - Acetylene

Inlet pressure $P_1 = \text{bar}$

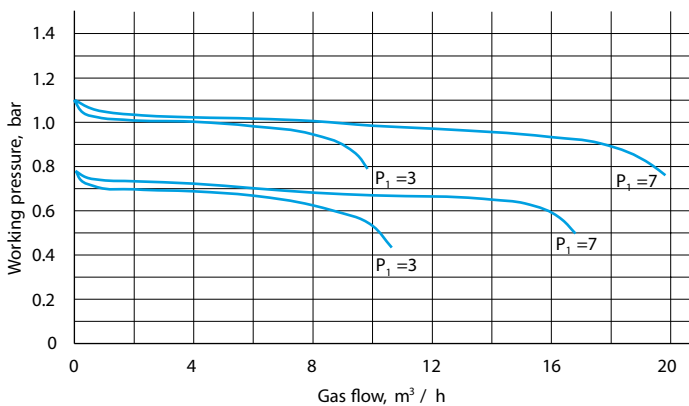

Capacity curves - Oxygen

Inlet pressure $P_1 = \text{bar}$

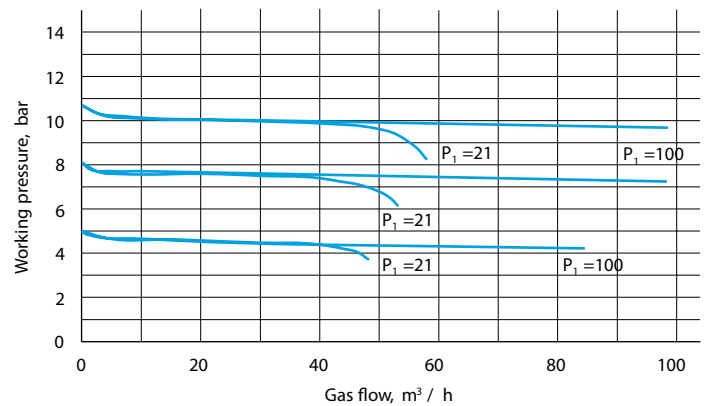

For gases other than oxygen, these factors must be used to calculate the regulator capacity:

Hydrogen	4.01
Helium	2.84
Argon	0.90
Nitrogen	1.08
Carbondioxide	0.85

Gas flow = oxygen x factor = m³ / h

Central regulator MR-60.

MR-60 is included as standard in central gas manifolds of type DUPLEX for bundles, MIC-60 and AUTOFILL.

MR-60 is used when high gas consumption is required from cylinders or bundles.

The regulator is a robust construction with very fine regulating characteristics, and has a significantly larger capacity than comparable regulators. The MR60 series are delivered with CE market safety valves for protection of the regulator and the low pressure components in the system. The safety valve is delivered with stainless steel pipe on outlet, $\varnothing 16 \times 3$ mm for welding to evacuation pipe.

Combustible gases:

Inlet coupling W 21.8 x 1/14" LH

Pipe weld adapter on outlet $\varnothing 23.7 \times 2.8$ mm of stainless steel, EN

1.4301 Outlet threads G 1" LH

Non- combustible gases:

Inlet coupling W 8 x 1/14" RH

Pipe weld adapter on outlet, $\varnothing 23.7 \times 2.8$ mm of stainless steel, EN

1.4301 Outlet threads G 1" RH



Gas	Inlet Pressure	Max. Outlet Pressure	Safety function	Safety valve, set pressure	Article no.
Acetylene	20 BAR	1,1 BAR	Safety valve	1.5 bar	322645 (0762907)
Hydrogen	200 BAR	12 BAR	Safety valve	18 bar	322643 (0762905)
Propane	25 bar	4 BAR	Safety valve	6 bar	322642 (0762903)
Oxygen	200 BAR	12 BAR	Safety valve	18 bar	322641 (0762906)
Argon	200 BAR	12 BAR	Safety valve	18 bar	322644 (0762904)

Capacity curves - Acetylene

Inlet pressure $P_1 = \text{bar}$

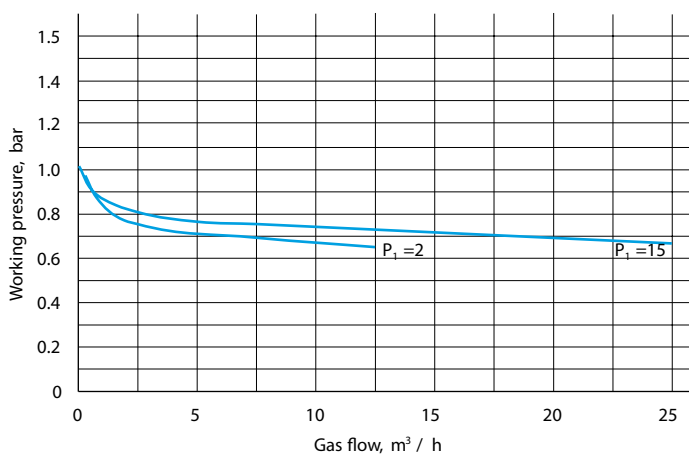

Capacity curves - Oxygen

Inlet pressure $P_1 = \text{bar}$

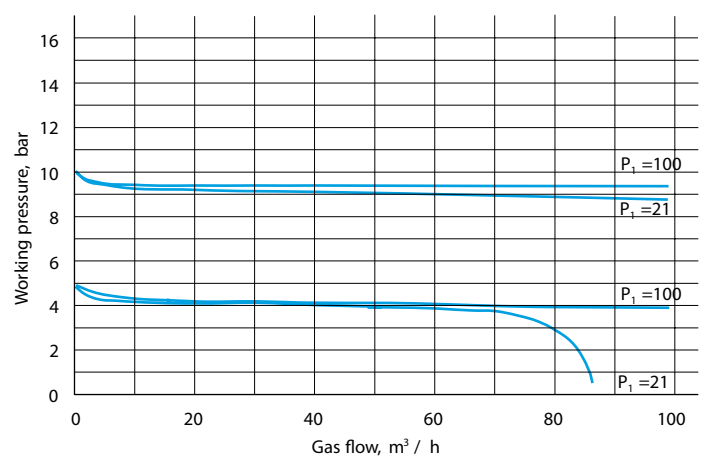

Safety valve.

The safety valve protects piping and components in the gas supply against abnormal pressure increase. The safety valve should be chosen for the specific installation and installed at the low pressure side after the manifold. Some of our manifolds have an integrated safety valve.

A ventilation pipe should be connected to the outlet. According to the European Pressure Equipment Directive, safety valves should be CE market.

Technical specification:

Material brass
 CE market
 Min. temp. – 20° C
 Length 150 mm
 Weight 0,4 kg
 Inlet 1/4" NPT ext threads
 Outlet stainless steel pipe 16 x 3 mm

Complete central gas manifold for bundles

Gas	Description	Article no.
Oxygen, inert gases	Safety valve 18 bar, 1/4" NPT Ext.	324060 (5489 000 80 518)
Acetylene	Safety valve 1,5 bar, 1/4" NPT Ext.	324051 (5488 1520 03 56)
Propane	Safety valve 6 bar, 1/4" NPT Ext.	330462 (548815200356)
Safety valve kit oxygen , inert gases	18 bar	330487 (9626400)
Safety valve kit acetylene	1,5 bar	330489 (9626510)
Safety valve kit propane	6 bar	330501 (9626500)



High pressure hoses.

The flexible high-pressure hoses for the industrial central gas manifolds are produced in accordance with the EN 14.113 standard: "Rubber and plastic hose connections for compressed and liquid gases." High pressure hoses for oxygen have special requirements.

The hoses are marked with:

- Linde
- Part number
- Production date
- Test pressure
- The gas name

The high-pressure hoses have a stainless steel braided steel mantle with an inner hose of PTFE or ETFE, and a safety wire fitted outside the moveable part of the hose. The nuts in both ends of the hoses are made of stainless steel.

The safety wire has a loop, which must be fastened to the cylinder valve. The high-pressure hoses are manufactured to the highest specifications, and all are quality-controlled before delivery.

The high-pressure hoses for combustible gases and welding gases are equipped with a non-return valve in the inlet coupling, which ensures overpressure in the hose when cylinders are disconnected.

Hoses of 1000 mm length are intended for cylinders, while hoses with 2000 mm or 3000 mm length are intended for bundles.

The high pressure hoses must be checked regularly and exchanged at regular intervals according to local guidelines.



High-pressure hoses for cylinder (1000 mm).



High-pressure hose for gas bundle (2000 mm or 3000 mm).

Product specifications

Gas	Cylinder valve thread	Cylinder coupling type *	DIN no.	Inlet pressure bar	Material, inner hose, mm	Diam., inner hose, mm	Length mm	Article no.
Acetylene	R3/4"RH	S,B	12	200	PTFE	6	1000	301943 (215 192 021)
						8	2000	301944 (215 192 022)
						8	3000	308716 (215 192 023)
Oxygen - Carbon dioxide	W21,80 x 1/14"RH	M	6	200	PTFE	6	1000	301945 (215 192 024)
						8	2000	301946 (215 192 025)
						8	3000	308715 (215 192 026)
Nitrogen - Helium - Argon	W24,32 x 1/14"RH	M,B	10	200	ETFE	6	1000	301947 (215 192 029)
						8	2000	301930 (215 192 030)
						8	3000	307250 (215 192 031)
Hydrogen - Methane	W21,80 x 1/14"LH	M,B	1	200	ETFE	6	1000	301988 (215 192 032)
						8	2000	308714 (215 192 033)
Air	R5/8"RH	S	7	200	PTFE	6	1000	301971 (215 192 038)
						8	2000	301968 (215 192 039)
Thermolene	W21,8 x 1/14"RH	S,B	-	200	PTFE	6	1000	303600 (219 500 514)
** Propane	POL	S,B	-	200	PTFE	6	1000	303601 (215 191 034)

* S = Screw, M = nut, B = return stop valve

** Propane thread for Norway and Sweden.

Specifications

	High pressure hoses for cylinders	High pressure hoses for cylinder bundles
Inner diameter	Ø 6 mm	Ø 8 mm
Min. bendingradius	50 mm	80 mm

Gaskets for cylinder couplings, pc.

Gas	Equipment	Dimensions	Article no.
Acetylene, air	Aluminium	Ø 14 / 10 x 1,0	303305 (100 000 933)
Oxygen and other gases	Aluminium	Ø 16 / 12,5 x 1,5	301523 (200 065 522)

Aluminium gaskets are used on the high pressure hose's outlet side and should be checked every time the cylinders are disconnected.

High pressure manifold tubes and cylinder brackets.

The cylinder manifold consists of high pressure pipe for connecting the high pressure hoses.

Specifications:

- High-pressure pipe Stainless steel, EN 1.4401
- Details Brass
- Wall bracket Stainless steel EN 1.4301
- Inlet pressure 200 bar

All high pressure manifold tubes for combustible gases have W 21.8 x 1/14" left-handed threads-for other gases they have W 21,80 x 1/14" right-handed threads.

The high pressure manifold tubes allows for connection of two or four high-pressure hoses. Two or more tubes can be assembled together to increase the number of connected cylinders.

When using several manifold tubes these can either be mounted on one

wall or they can be mounted on two walls. For the latter alternative, extension pipe with 90 degree bends is used in the corner.

High pressure manifold tubes for gas bundles are available for one or two gas bundles. These are fastened to the wall by the valves' wall brackets.

Cylinder brackets are available for 1 or 2 gas cylinders. They consist of a wall bracket in stainless steel EN 1.4301 and a chain of galvanized steel. All cylinders should be secured with cylinder brackets to prevent overturn.

An overturned cylinder can precause harm damage on people or other materials. If the cylinder valve are damaged, the cylinder can start rotating uncontrolled.

Cylinders on ships or other moveable installation need to be secured by a fixed bracket.

Manifold tubes for cylinders.

Length mm	No. of gas cylinders	Gas	Article no.
579	2	Combustible gas	301962 (215 191 070)
1159	4	Combustible gas	301965 (215 191 071)
579	2	Non - combustible gases	301963 (215 191 072)
1159	4	Non - combustible gases	301967 (215 191 073)

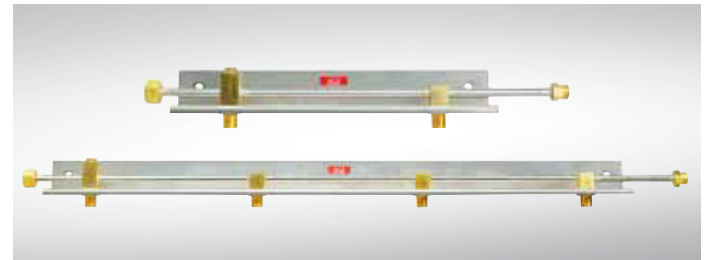

Cylinder brackets for cylinders.

Length mm	No. of gas cylinders	Article no.
260	1	301937 (215 191 074)
550	2	301957 (215 191 075)



Manifold tubes for bundles.

Length mm	No. of gas cylinders	Gas	Article no.
289	1	Combustible gas	301990 (215 191 007)
579	2	Combustible gas	301989 (215 191 008)
289	1	Non- combustible gases	301877 (215 191 012)
579	2	Non- combustible gases	301981 (215 191 013)

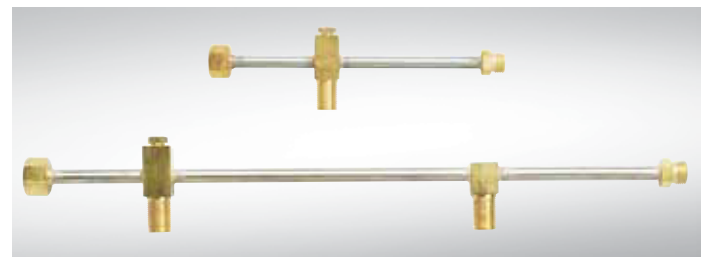

High pressure components for central gas manifolds.

All components are designed and manufactured in accordance with the applicable and relevant norms and standards for high pressure systems.
All components are assembled with aluminum gaskets.

Specifications:

Stainless steel, EN 1.4404

Brass details

Inlet pressure 200 bar

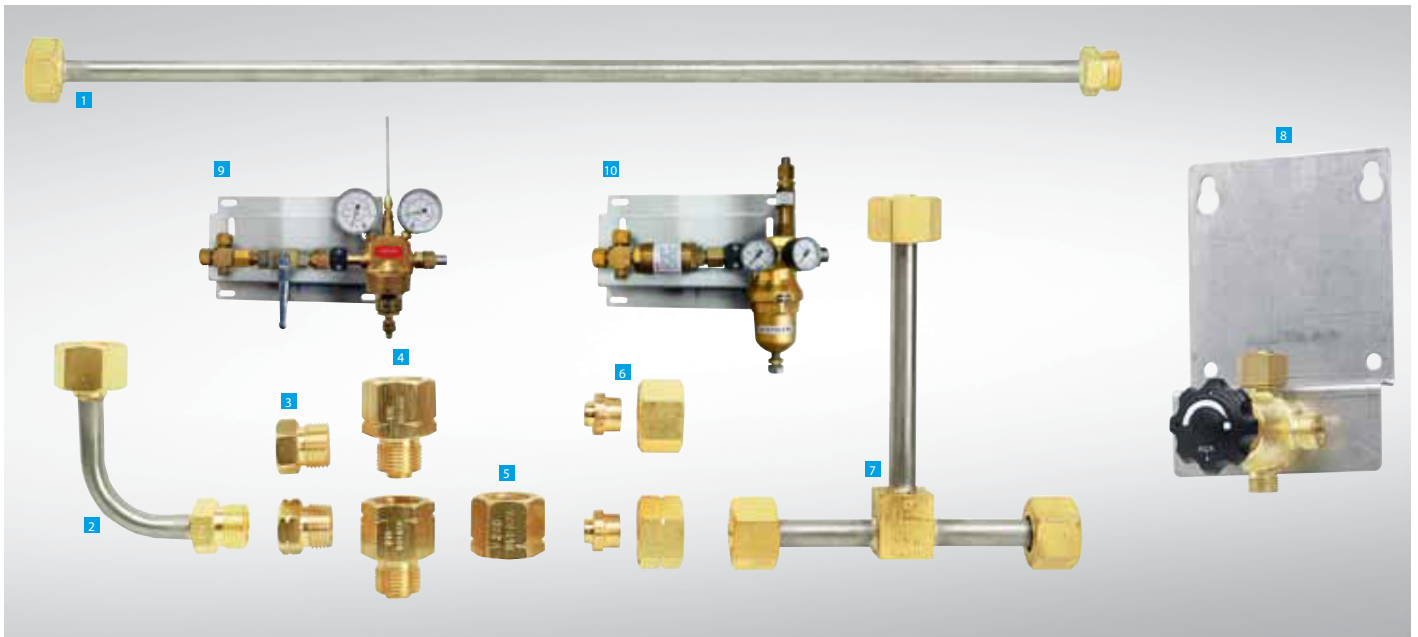

Pos	Description	Gas	Coupling	Article no.
1	Extension pipe 700 mm	Combustible gas	W 21.8 x 1/14" LH ext. - int.	303589 (215 191 006)
		Non- combustible gas	W 21.8 x 1/14" RH ext. - int.	303591 (215 191 011)
2	Elbow coupling 90°	Combustible gas	W 21.8 x 1/14" LH ext. - int.	301950 (215 191 005)
		Non- combustible gas	W 21.8 x 1/14" RH ext. - int.	301954 (215 191 010)
3	Blank with gasket	Combustible gas	W 21,8 x 1/14" LH ext.	301949 (215 191 076)
		Non- combustible gas	W 21,8 x 1/14" RH ext.	301958 (215 191 077)
4	Transition exterior-interior	Combustible gas	W 21.8 x 1/14" RH int. - W 21.8 x 1/14" LH ext.	301951 (215 191 069)
		Non- combustible gas	W 21.8 x 1/14" LH int. - W 21.8 x 1/14" RH ext.	301952 (215 191 068)
5	Nut right-left threads	-	W 21.8 x 1/14" LH - W 21,8 x 1/14" LH int.	301636 (200 059 835)
6	Blank with nut/ gasket	Combustible gas	W 21,8 x 1/14" LH int.	301959 (215 191 081)
		Non- combustible gas	W 21,8 x 1/14" RH int.	301966 (215 191 080)
7	T-pipe for DUPLEX	Combustible gas	W 21,8 x 1/14" LH int.	301931 (215 191 084)
		Non- combustible gas	W 21,8 x 1/14" RH int.	301932 (215 191 085)
8	Valve module	Combustible gas	W 21,8 x 1/14" LH ext.	301985 (203 010 663) *)
		Non- combustible gas	W 21,8 x 1/14" RH ext.	301986 (203 010 662)
9	Valve module MR21	Acetylene	-	330255 (9624120)
10	Valve module MR60	Acetylene	-	330256 (9624130)
	Aluminium gasket		16 x 12,5 x 1,5 mm	301523 (200 065 522)

Gas pre-heater 300W.

A gas pre-heater may in certain instances be necessary to prevent irregularity caused by icing in gas stream through the central regulator. Pre-heater is installed on the high pressure side, immediately ahead of the central regulator. The gas pre-heater is intended for carbon dioxide and argon mixtures, but is not approved for oxygen and combustible gases. A gas pre-heater will increase the regulator capacity and ensure stable gas regulation. It will also increase the lifetime of the central regulator.

The CE market pre-heater is equipped with thermostat and melt fuse to prevent over heating.

The 300 watt output needs to be considered and compared to the gas consumption.



Voltage connection	Power	Gas capacity	Inlet pressure	Inlet threads	Outlet threads
230 volts, 50 Hz	300 watts	6 Nm ³ / h	200 bar	W 21,8 x 1/14" int. RH	W 21,8 x 1/14" ext. RH
Encapsulation class	Thermostat control	Safety fuse	Nipple pipe	Article no.	
IP54	70° C	120° C	Stainless steel EN 1.4401	301794 (206 282 060)	
Aluminium gasket					
16 x 2.5 x 1.5 mm					301523 (200 065 522)

Installation of pre-heater.

When installing a gas pre-heater, a spacer must be placed between the wall and the manifold.



Simplex

The manifold and the pre - heater should be installed in dry condition and in a tempered room.



Duplex

High-pressure valves.

High pressure valve DN 3 for combustibles gases.

Seat valve for central manifolds, intended for installation between manifold tube and high pressure hose.



Weight	Height / Length	Inlet pressure	Inlet	Outlet	Article no.
0,5 kg	90 / 54 mm	200 bar	W 21,80 x 1/14" LHext.	W 21,80 x 1/14" RH ext.	301953 (203 010 633)
Aluminium gaskets					
16 x 2.5 x 1.5 mm					301523 (200 065 522)

High pressure valve DN 6 for combustibles gases.

Seat valve for DUPLEXbundle manifolds, intended for installation between manifold tube and high pressure hose.



Weight	Height / Length	Inlet pressure	Inlet	Outlet	Article no.
0,9 kg	110 / 70 mm	200 bar	W 21,80 x 1/14" LHext.	W 21,80 x 1/14" LHext.	301955 (203 010 660)
Aluminium gaskets					
16 x 2.5 x 1.5 mm					301523 (200 065 522)

High pressure valve DN 3 for non- combustibles.

Seat valve for central manifold tube for installation between manifold tube and high pressure hose.



Weight	Height / Length	Inlet pressure	Inlet	Outlet	Article no.
0,5 kg	90 / 54 mm	200 bar	W 21,80 x 1/14" RH ext.	W 21,80 x 1/14" LH ext.	301632 (203 010 424)
Aluminium gaskets					
16 x 2.5 x 1.5 mm					301523 (200 065 522)

High pressure valve DN 6 for non - combustibles.

Seat valve for bundle manifolds for installation between manifold tube and high pressure hose.



Weight	Height / Length	Inlet pressure	Inlet	Outlet	Article no.
0,9 kg	110 / 70 mm	200 bar	W 21,80 x 1/14" RH ext.	W 21,80 x 1/14" RH ext.	301634 (203 010 533)
Aluminium gaskets					
16 x 2.5 x 1.5 mm					301523 (200 065 522)

High-pressure valves.

Three-way valves.

Seat valves, 3 - port DN - 6

3 - port valve is a part of the, MIC60 and AUTO-FILL manifold. The valve has 2 inlets and 1 outlet.

The valve does not close off between inlets and the one outlet blinded off. The valve is mounted before the central regulator.



High pressure valve, 3 - port, non-combustible gases.

Weight	Height / Length	Inlet pressure	Inlet	Outlet	Article no.
1,2 kg	118 / 80 mm	200 bar	W 21,80 x 1/14" RH ext.	W 21,80 x 1/14" RH ext.	301972 (202 502 284)

High pressure valve, 3 - port, combustible gases.

Weight	Height / Length	Inlet pressure	Inlet	Outlet	Article no.
1,2 kg	118 / 80 mm	200 bar	W 21,80 x 1/14" LH ext.	W 21,80 x 1/14" LH ext.	301973 (203 010 661)

Aluminium gaskets

16 x 2.5 x 1.5 mm	301523 (200 065 522)
-------------------	------------------------

High-pressure valves DN 6 with wall bracket.

High pressure valve DN 6 for combustible gases.

Seat valve intended for installation in connection with manifold for bundles. It is used for Duplex and MIC 60 or other bundle manifolds with 2+2 bundles.

The valve is fitted with a filter on the inlet side. This particle filter protects the central regulator. The valve is mounted on a wall bracket.



Weight	Height / Length	Inlet pressure	Inlet	Outlet	Article no.
2,0 kg	252 / 150 mm	200 bar	W 21,80 x 1/14" LH ext.	W 21,80 x 1/14" LH int.	303627 (215 191 087)
Aluminium gaskets					
16 x 2.5 x 1.5 mm					301523 (200 065 522)

High pressure valve DN 6 for non-combustible gases.

Seat valve for installation in connection with manifold for bundles DUPLEX, MIC 60 and other central bundle manifolds with 2+2 bundles.

The valve is fitted with a filter on the inlet side. This particle filter protects the central regulator. The valve is mounted on a wall bracket.

Weight	Height / Length	Inlet pressure	Inlet	Outlet	Article no.
2,0 kg	252 / 150 mm	200 bar	W 21,80 x 1/14" RH ext.	W 21,80 x 1/14" RH int.	301631 (215 190 217)
Aluminium gaskets					
16 x 2.5 x 1.5 mm					301523 (200 065 522)

High pressure filter.

The filter's primary function is to protect the central regulator from particles. This can cause operating problems in the form of unstable pressure, pressure increase on the secondary side of the regulator or blow off of the pressure relief valve. The filter is used on Duplex, MIC 60 and AUTOFILL.

The filter element is made of brass. In addition a non-return valve is incorporated.

Inlet pressure 200 bar.

The high-pressure filter for combustible gases has W 21.8 x 1/14" left-handed threads and for non-combustible gases W 21,8 x 1/14" right-handed threads.

Gas	Article no.
Combustible gas	301956 (215 191 086)
Non-combustible gases	301613 (215 190 042)
Aluminium gasket	
16 x 2.5 x 1.5 mm	301523 (200 065 522)



Non-return valve.

The non-return valve is installed between high pressure hose and manifold tube. It is an important safety feature. It is there to prevent fill-over of gas from one cylinder to another. In addition, in the event of a high-pressure hose rupture, it is to prevent gas escaping from more than one cylinder.

The non-return valve is made of brass.

Inlet pressure 200 bar.

The non-return valve for combustible gases has W 21.8 x 1/14" left-handed threads and for non-combustible gases W 21,8 x 1/14" right-handed threads.

Gas	Article no.
Combustible gas	301979 (215 191 043)
Non-combustible gases	301849 (215 191 044)
Aluminium gasket	
16 x 2.5 x 1.5 mm	301523 (200 065 522)



Flashback arrestor.

SUPER 55.

The flashback arrestors should be installed at tapping points for combustible gas and oxygen when these are used for gas welding, cutting or heating.

SUPER 55 has four safety functions:

- Prevents backflow.
- Stops and extinguishes back-burning.
- Cut off the supply of gas in the event of pervasive backflow.
- Cut off the supply of gas in the event of overheating.

When SUPER 55 is closed caused by backflow or flashback, this is indicated by a red colour. Reset is done by lifting the cover until the red indicator disappears.

SUPER 55 is suitable to most types of work except high capacity application.

The capacity can be doubled by using two SUPER 55 in parallel.



Capacity curves

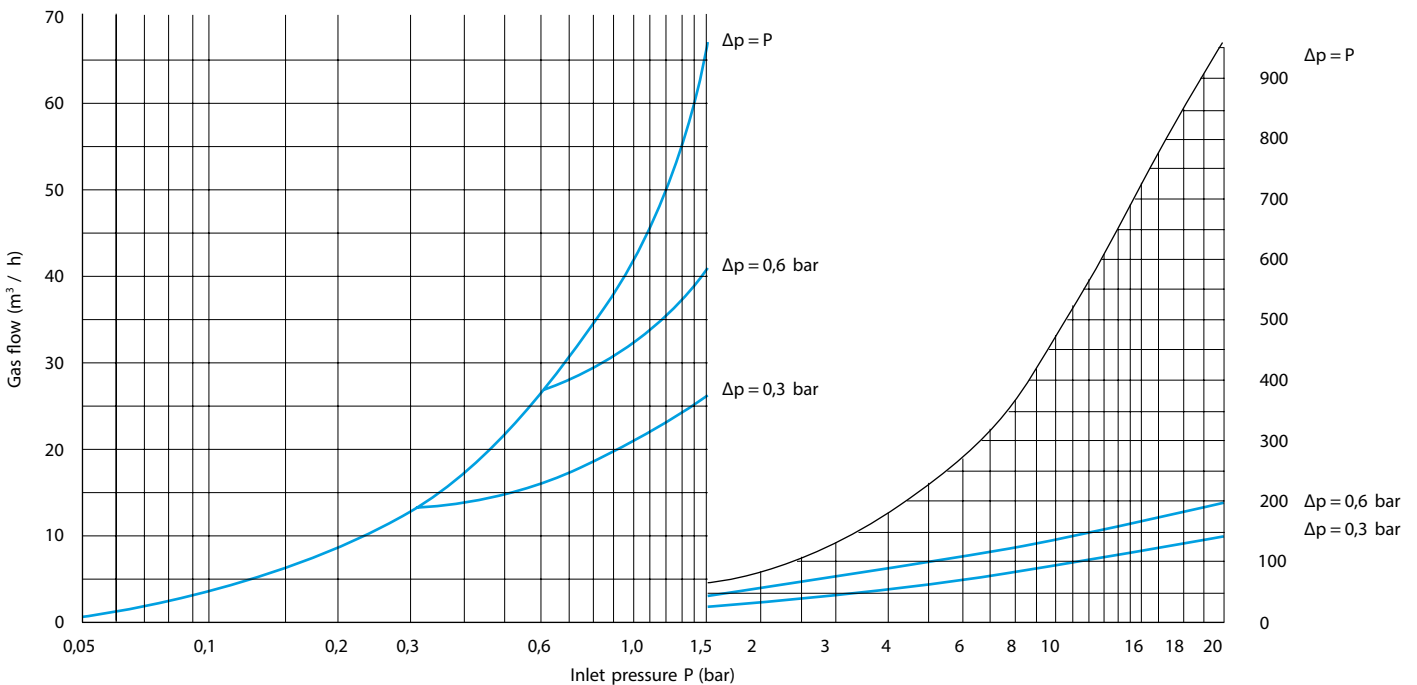

Type	Gas	Max. inlet pressure, bar	Connections	Article no.
SUPER 55	Acetylene	1,5	G 3/8" LH	316570
	Propane	5,0	G 3/8" LH	316570
	Hydrogen	3,0	G 3/8" LH	316570
	Oxygene	20,0	G 3/8" RH	316571

Flashback arrestor.

SAFE - GUARD- 4.

Flashback arrestors should be installed at tapping points for fuel gas and oxygen when these are used for gas welding, cutting or heating.

SAFE - GUARD- 4 has four safety functions:

- Prevents backflow.
- Stops and extinguishes back-burning.
- Cut off the supply of gas in the event of pervasive backflow.
- Cut off the supply of gas in the event of overheating

When SAFE - GUARD- 4 is open and in operation, this is indicated by green colour. In the event of a backflow the green indicator disappears. It can be opened again by depressurizing on both sides of the flashback arrestor and then lifting the cover until the indicator again shows green and the valve is open.

SAFE - GUARD- 4 is suitable to most types of work except high capacity application.

The capacity can be doubled by using two SAFE - GUARD- 4 in parallel.



SAFE - GUARD- 4 Oxygen

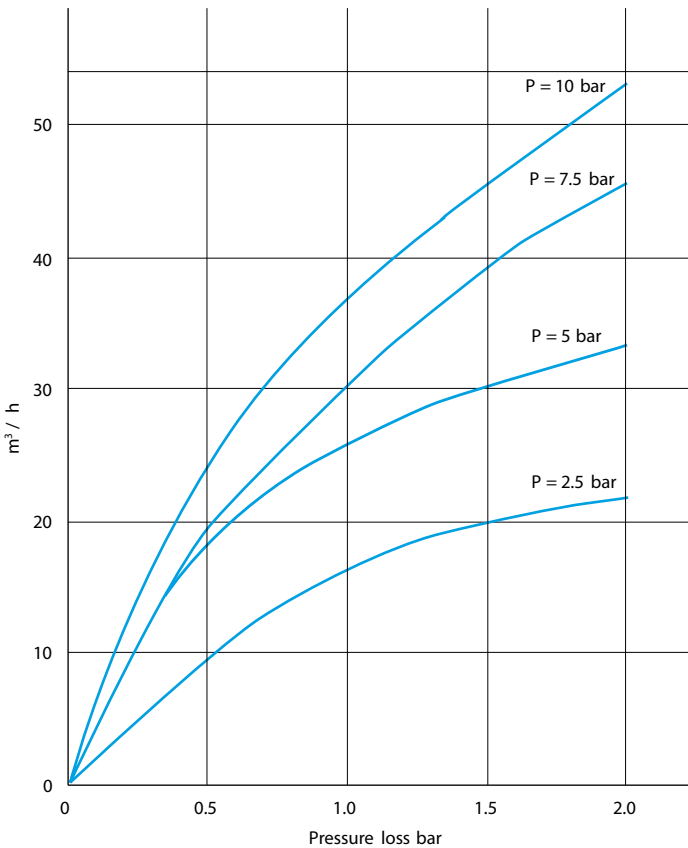

SAFE - GUARD- 4 Acetylene

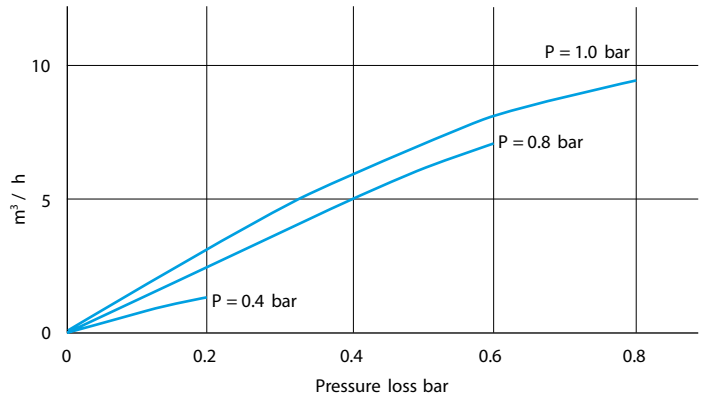

Gas	Coupling	Max. inlet pressure	Article no.
Acetylene	3/8" LH	1,5 bar	300250 (203 011 136)
Propane	G 3/8" LH	5,0 bar	300250 (203 011 136)
Hydrogen	G 3/8" LH	3,0 bar	300250 (203 011 136)
Oxygen	3/8" RH	10 bar	300251 (203 011 137)

Flame arrestor / flashback arrestor.

85 - 10.

The 85- 10 can be used as a flashback arrestor on tapping points for cutting machines.

85 - 10 has a flame filter and a melt fuse and must always be installed directionally. Furthermore, 85 - 10 has a brass filter with a large surface and a non-return valve to prevent backflow. 85 - 10 shuts off the gas in the event of overheating as a consequence of e.g. a backfire.

85 - 10 is also in some cases used as a flame arrestor in very small distribution networks when the distance between the central regulator and the outlet point is short, and when there is only one outlet.

A suitable type of central gas manifold is the SIMPLEX central manifold with 1 cylinder. 85 - 10 can also be used for other combustible gases.

The flame arrestor for the combustible gas has G 3/8" LH-threads with a conic sealing surface at both ends. Oxygen has G3/8" RH.

The 85-10 is also for oxygen in oxy - fuel processes.

The weld adapters are only used when the 85-10 is used as flame arrestor in line.



Pos	Gas	Max. inlet pressure	Article no.
1	85-10 for combustible gases	1,5 bar	301978 (219 500 018)
2	Pipe weld adapter on inlet, Ø 12 mm stainless steel, EN 1.4571		309845
3	Pipe weld adapter on outlet, stainless steel, EN 1.4571		309846
4	Couplingnut, outlet 3/8" LH		309847
5	85-10 for oxygen	30 bar	303737 (20 018 932)

Capacity curves

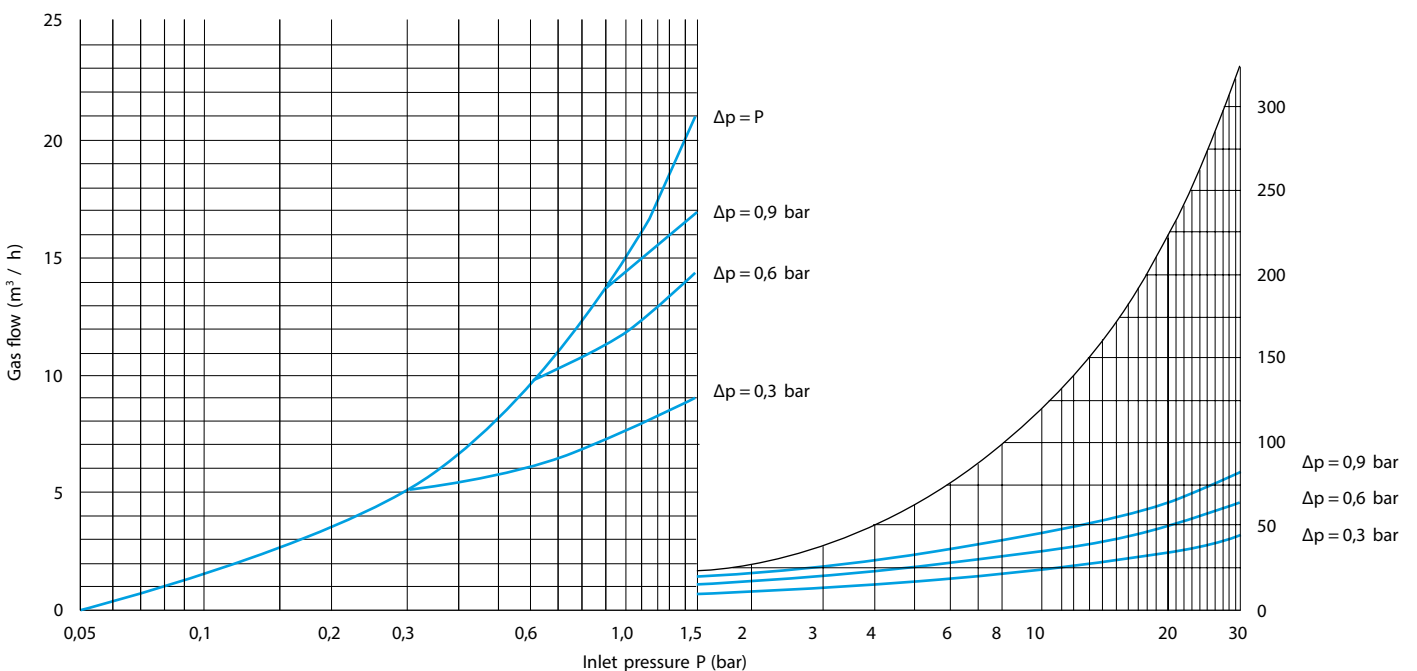

Flame arrestor / flashback arrestor.

85 - 30.

A flame arrestor must always be installed in the distribution network after the central gas manifold for acetylene.

The task of a flame arrestor is to prevent a backflow from getting into the gas cylinders.

85 - 30 has a flame filter and a melt fuse and must always be installed directionally. The flame filter extinguishes any gas fire in the pipe which spreads toward the central gas manifold. The melt fuse cut off the supply of gas in the event of overheating, for example in the event of fire.

85 - 30 is used as a flame arrestor. For high capacity two flame arrestors in parallel can be installed. The flame arrestor has a non-return valve which prevents return flow of gas back toward the central manifold.

The flame arrestor can also be used for other combustible gases.

The flame arrestor for acetylene has G 3/4" - LH - threads with a conical sealing surface at both ends.

Maximum pipe diameter for acetylene must be within the safety range to avoid acetylene decomposition.

Contact Lind for more information.

Two 85-30 can be installed in parallel to double the capacity.

The 85-30 for oxygen is intended for use at tapping points for cutting oxygen.



It can also be used on outlets with heavy consumption, And especially for the cutting-oxygen for machine cutting. The oxygen device has G3/4" RH in both ends with conical connections.

Pos	Gas	Max. inlet pressure	Article no.
1	85-30 for combustible gases	1,5 bar	310596 (219 500 017)
2	Pipe weld adapter on outlet, Ø 26, 9 mm stainless steel, EN 1.4571		309843
3	Pipe weld adapter on inlet, 26,9 mm stainless steel, EN 1.4571		309844
4	85-30 for oxygen	30 bar	303741

Capacity curves

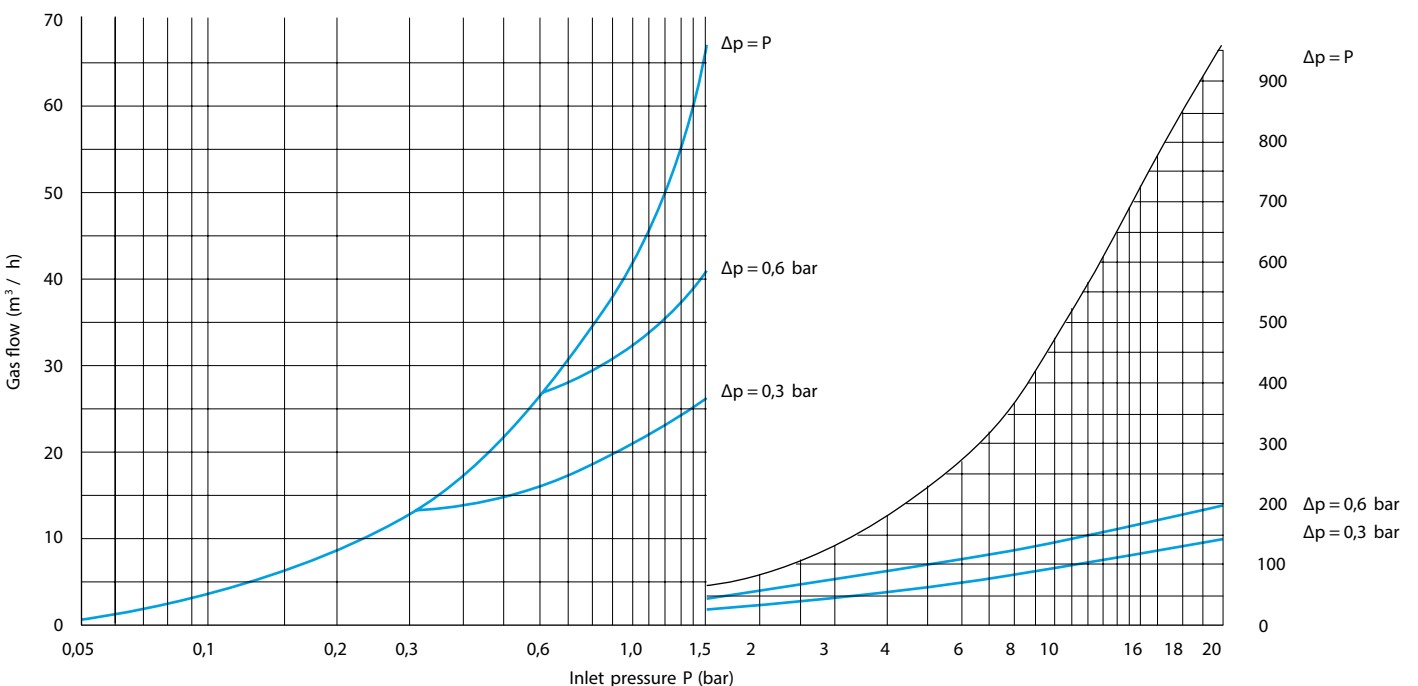

Low pressure valves.

Shut-off valves are important components for safety and functionality in a gas supply system. When the system is planned, it is important to select correct placement of the shut-off valves.

A shut-off valve should be installed immediately following the central gas manifold. Right before or after insertion into a workplace / workstation, a shut-off valve must be installed for safety and service purposes. All tapping points are equipped with a shut-off valve. AGA's ball valves are especially manufactured for industrial gases: acetylene, oxygen, argon, argon mixtures, carbon dioxide, nitrogen and hydrogen.

The ball valves are designed so that they are secured against inadvertent gas blowouts, and are degreased for use with oxygen. The gasket seal is made of PTFE. The spindle is sealed with two O-rings of silicon and a teflon gasket. The valve casing's two halves have O-ring sealing of EPDM.

Reference

- 1 Ball valve DN 10, DN 15 and DN 25
- 2 Union nut, 2 pcs. per package
- 3 Pipe weld adapter in black steel, 2 pcs. per package
- 4 Pipe weld adapter of stainless steel EN 1.4301, 2 pcs. per package
- 5 Soldering sleeves of brass, 2 pcs. per package
- 6 Gaskets, pc.

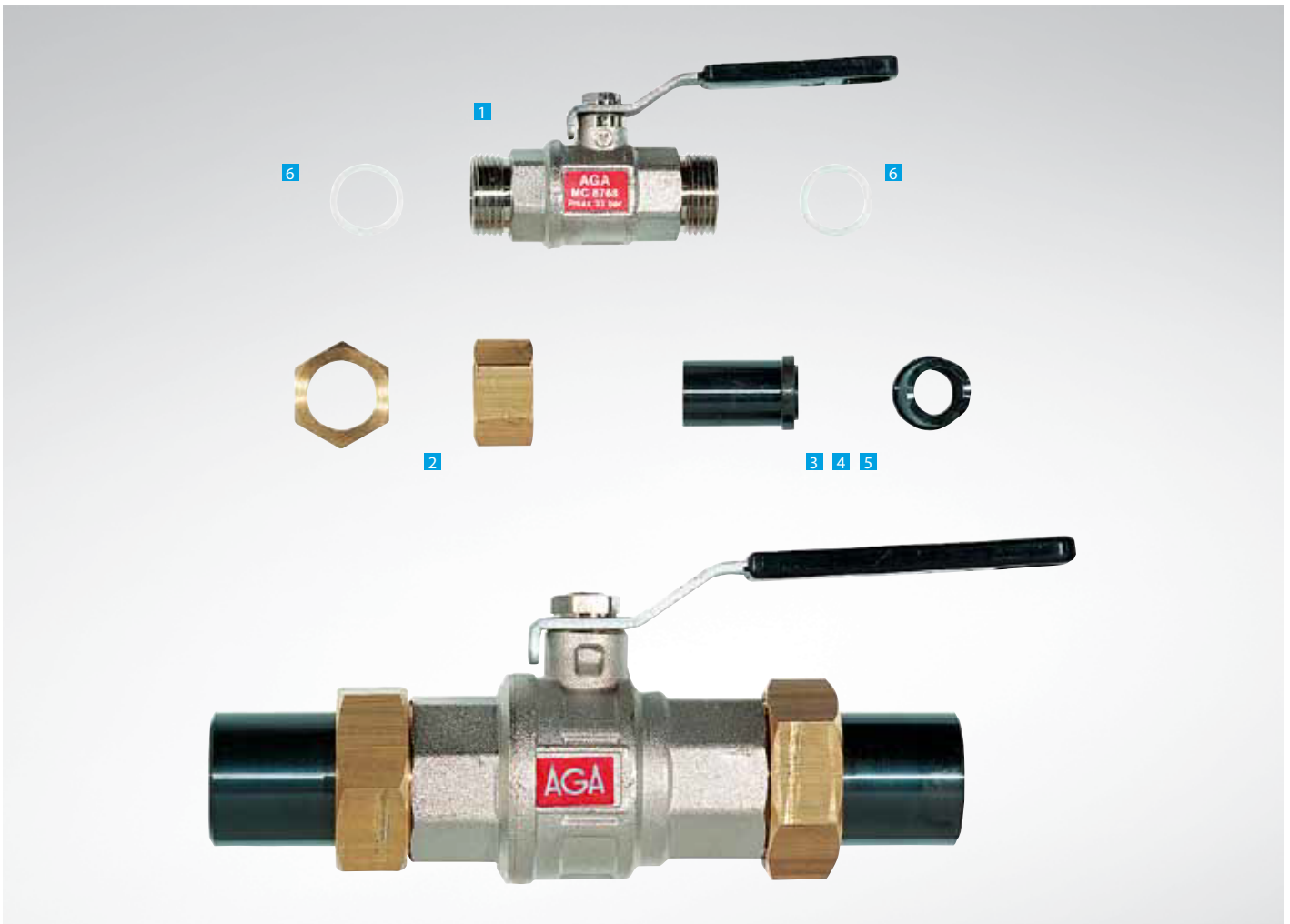

Specifications:

- Valve casing Nickel plated brass
- Valve ball Chromed brass
- Valve spindle Nickel plated brass
- Max. inlet pressure 40 bar

1. Ball valve DN 10, DN 15 and DN 25

Description	Gas	Coupling thread	Length mm	Article no.
DN 10	Non- combustiblegas	ISO - G1/2" RH	67	309656 (215 191 139)
DN 15	Non- combustiblegas	ISO - G 3/4" RH	77	301764 (215 191 140)
DN 15	Combustiblegas	ISO - G 3/4" LH	77	301776 (215 191 141)
DN 25	Non- combustiblegas	ISO G 1 1/4" RH	115	301765 (215 191 142)
DN 25	Combustiblegas	ISO G 1 1/4" LH	115	301737 (215 191 143)

Ball valves are delivered with 2 gaskets. In addition come nuts and welding nipples or soldering sleeves.

2. Union nut, 2 pcs. per package

Description	Gas	Coupling thread	Article no.
DN 10	Non- combustiblegas	ISO - G1/2" RH	301792 (202 502 266)
DN 15	Non- combustiblegas	ISO - G 3/4" RH	301731 (202 502 268)
DN 15	Combustiblegas	ISO - G 3/4" LH	301733 (202 502 267)
DN 25	Non- combustiblegas	ISO G 1 1/4" RH	301734 (202 502 270)
DN 25	Combustiblegas	ISO G 1 1/4" LH	301730 (202 502 269)

3. Pipe weld adapter in black steel, 2 pcs. per package

Description	Length mm	Pipe dimension mm	Article no.
Pipe weld adapter DN 10	26,5	13,5 x 1,8	301772 (202 080 597)
Pipe weld adapter DN 15	36,5	21,3 x 2,0	301773 (202 080 599)
Pipe weld adapter DN 25	46,5	33,7 x 2,6	301774 (202 080 601)

4. Pipe weld adapter of stainless steel EN 1.4301, 2 pcs. per package

Description	Length mm	Pipe dimension mm	Article no.
Pipe weld adapter DN 10	26,5	13,5 x 1,6	301775 (202 080 598)
Pipe weld adapter DN 15	36,5	20,0 x 2,0	301770 (202 080 600)
Pipe weld adapter DN 25	46,5	33,7 x 2,6	301732 (202 080 602)

5. Soldering sleeves of brass, 2 pcs. per package

Description	Pipe dimension mm	Article no.
Soldering sleeve	DN 10	10 / 15
Soldering sleeve	DN 10	12
Soldering sleeve	DN 15	15 / 22
Soldering sleeve	DN 15	18
Soldering sleeve	DN 25	22 / 35
Soldering sleeve	DN 25	28

6. Gaskets, pc.

Description	Material	Valve	Article no.
Gasket	PTFE	DN 10	307723 (325 110 373)
Gasket	PTFE	DN 15	301758 (325 100 729)
Gasket	PTFE	DN 25	301757 (325 100 730)

Tapping point shielding gas.

Single tapping point.

JETSETapping point for argon and argon mixtures gives a safe and stable gas supply. Tapping points are user friendly and easy to service. The valve module is the basis for the tapping point. It is equipped with a ball valve DN 10, which can easily be observed to be open or closed. The inlet side of the valve module is delivered as standard with a stainless steel pipe weld adapter.

A regulator of type UNICONTROL700 is fitted on the underside of the valve module. This gives a constant pressure of 2.5 bar into the flow meter. Therefore, only an adjustment of the gas flow is necessary. The flow meter is adjusted using a needle valve. The tapping point can at a later time be expanded to a double tapping point using the ROTAM PLUS flow meter.

The tapping point consist of the following components:

- Regulator UNICONTROL700
- Flowmeter ROTAMPLUS with needle valve
- Valve module with stainless steel pipe weld adapter, Ø 14 x 2.4 mm
- Tension unloader for gas hose
- Hose connector for 5 mm hose



Gas	Max inlet pressure	Set pressure	Flowmeter	Article no.
Argon	25 bar	2,5 bar	0 - 30 l / min	301749 (203 310 251)

Double tapping point.

The tapping point consist of the following components:

- Regulator UNICONTROL700
- 2 x flowmeter ROTAMPLUS with needle valve 0 – 30 litre / minute
- Valve module with stainless steel pipe weld adapter Ø 14 x 2.4 mm
- Tension unloader for hose
- Hose connector 5 mm



Gas	Max inlet pressure	Set pressure	Flowmeter	Article no.
Argon	25 bar	2,5 bar	2 x 0 - 30 l / min	301748 (203 310 252)
FORMIER, VARIGONH5 and H10	25 bar	2,5 bar	2 x 0 - 30 l / min	318962 (0 764 219)

Single tapping point with manometer.

This tapping point adjusts the gas flow by regulating the pressure knob on the regulator.

It uses the regulator's regulating wheel to adjust the gas flow. Used for simpler welding tasks.

The outlet point consist of the following components:

- Regulator UNICONTROL700
- Flow meter 0 - 30 liters / min with manometerscale.
- Valve module with pipe weld adapter $\varnothing 14 \times 2.4$ mm
- Tension unloader for hose
- Hose connector 5 mm



Gas	Max inlet pressure	Flowmeter	Article no.
Argon	25 bar	0 - 30 l / min	316751 (203 310 292)

Tapping points for plasma cutting.

Single tapping point.

JETSETapping point for plasma nitrogen has a maximum outlet pressure of 13 bar.

The valve module is the basis for the tapping point. It is equipped with a ball valve DN 10, which can easily be observed to be open or closed. The inlet side of the valve module is delivered as standard with a stainless steel pipe weld nipple.

A regulator of type UNICONTROL700 is fitted on the outlet of the valve module. This gives a constant pressure.

The tapping point consist of the following components:

- Regulator UNICONTROL700
- Valve module with stainless steel pipe weld adapter, $\varnothing 14 \times 2.4$ mm
- Hose connector for 6,3 mm hose

[See Capacity curve Pg. 46.](#)



Gas	Max inlet pressure	Outlet pressure	Article no.
Plasma nitrogen	25 bar	0 - 13 bar	321513

Tapping point oxygen.

Single tapping point.

The JETSEToxygen tapping point provides a safe and stable gas supply. The tapping point is user-friendly and easy to service. The valve module, which is the outlet's key element, is equipped with a ball valve DN 10, and it is easy to see whether the valve is open or closed. The inlet side has a stainless steel pipe weld adapter as standard. A UNICONTROL700 regulator is mounted on the underside of the valve module. This is adjustable within an appropriate range and provides stable outlet pressure.



If the oxygen tapping point is used in oxy-fuel processes a flashback arrestor has to be installed.

The outlet is equipped with:

Regulator UNICONTROL700

Non-return valve

Valve module with a stainless steel pipe weld nipple

Ø 14 x 2.4 mm

Hose connector 6,3 +8 mm

Capacity curve

Inlet pressure P = bar

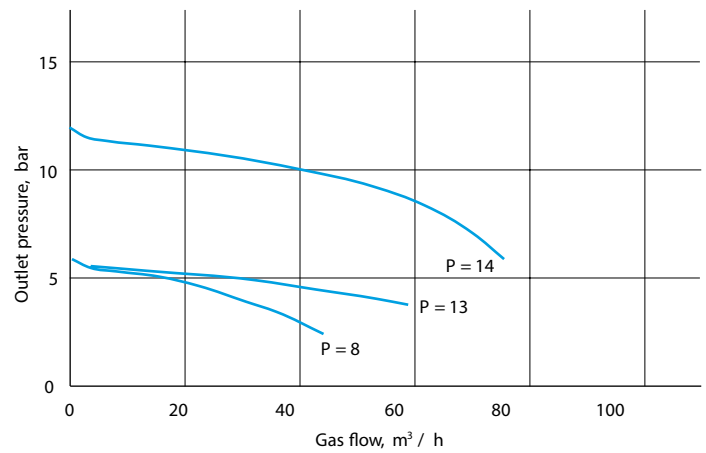

For gases other than oxygen, these factors must be used to calculate the regulator capacity:

Argon	0.90
Nitrogen	1.08

Gas flow = oxygen x factor = m³ / h

Gas	Max inlet pressure	Adjustment range	Article no.
Oxygen	25 bar	0 - 10 bar	301941 (203 310 268)

Single tapping point with R - 64 J.

The JETSETapping point with R - 64 J regulator is designed for high gas consumption.

The valve module is equipped with a ball valve DN 15 and a stainless steel pipe weld adapter on the inlet side.

This outlet may be used for all air gases including oxygen.

The tapping point has the following equipment:

Regulator JETEXR - 64 J, which provides an even and stable pressure

Valve module with a DN 15 valve and a stainless steel pipe weld adapter, $\varnothing 21.3 \times 3,1$ mm

Hose connector 10 mm + 12,5 mm



Capacity curve

Inlet pressure P = bar

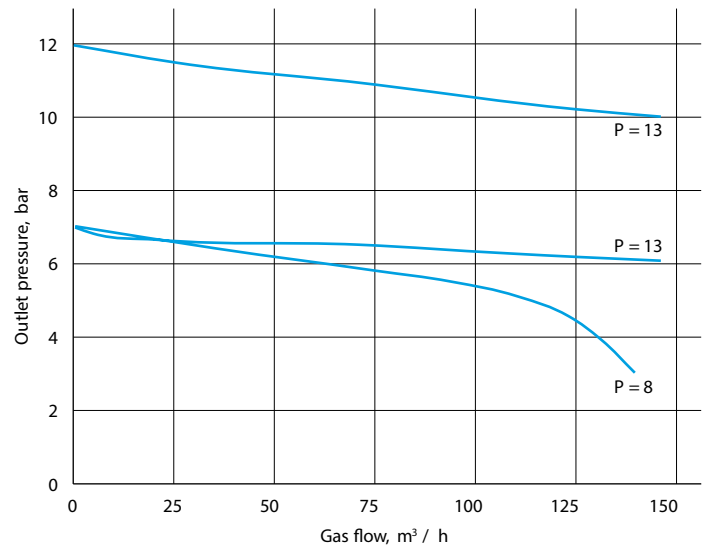

For gases other than oxygen, these factors must be used to calculate the regulator capacity:

Argon	0.90
Nitrogen	1.08

Gas flow = oxygen x factor = m³ / h

Gas	Max inlet pressure	Adjustment range	Article no.
Oxygen and other air gases	17 bar	2 - 16 bar	301760 (215 190 920)

Tapping points combustible gas.

Single acetylene tapping point.

The JETSET fuel gas tapping point provides a safe and stable gas supply. The outlet is user-friendly and easy to service. The valve module, which is the outlet's key element, is equipped with a ball valve DN 10, and it is easy to see whether the valve is open or closed.

The inlet side has a stainless steel pipe weld adapter as standard. A UNICONTROL700 regulator is mounted on the underside of the valve module. This is adjustable within an appropriate range and provides stable outlet pressure. Acetylene tapping points are delivered with flashback arrestor as standard.

SAFE - GUARD - 4 flashback arrestor is a multi-function safety device with the following four functions:

- Non-return valve
- Flame filter
- Pressure sensitive shut-off valve
- Thermal shut-off valve

Acetylene

The tapping point has the following equipment:

- Valve module with a stainless steel pipe weld adapter
Ø 14 x 2.4 mm
- Regulator UNICONTROL700
- Flashback arrestor SAFE - GUARD - 4
- Hose connector 6,3 mm and 8 mm



Capacity curve UNICONTROL 700

Inlet pressure P = bar

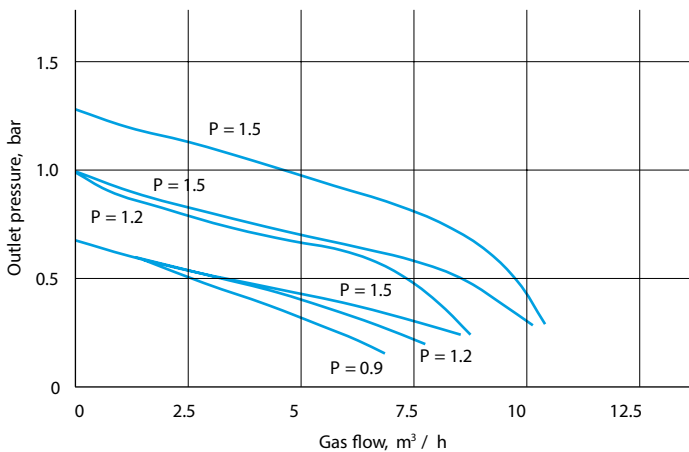

Capacity curve SAFE - GUARD - 4 Acetylene

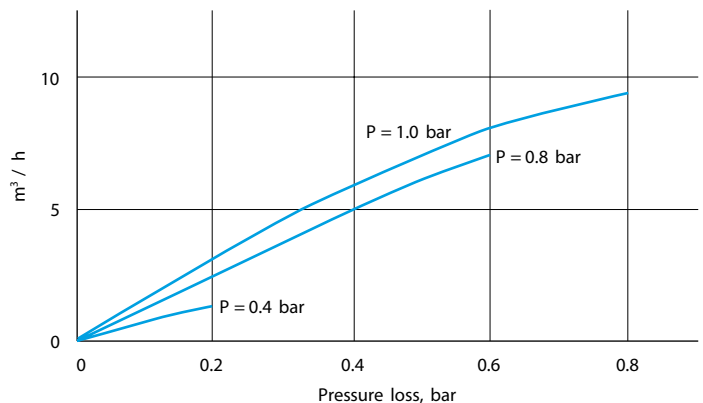

Gas	Max inlet pressure	Adjustment range	Article no.
Acetylene	1,5 bar	0 - 1,5 bar	301755 (203 310 240)

Tapping points for combustible gases.

The JETSET fuel gas tapping point provides a safe and stable gas supply.

The tapping point is user-friendly and easy to service.

The valve module, which is the tapping point's key element, is equipped with a ball valve DN 10, and it is easy to see whether the valve is open or closed.

The inlet side has a stainless steel pipe weld adapter as standard.

A UNICONTROL700 regulator is mounted on the underside of the valve module. This is adjustable within an appropriate range and provides stable outlet pressure.

Flashback arrestor has to be mounted if the tapping point is used together with oxygen.

Hydrogen and Propane

The tapping point has the following equipment:

Valve module with a stainless steel pipe weld adapter

Ø 14 x 2.4 mm

Regulator UNICONTROL700

Non-return valve

Hose connector 6,3 mm and 8 mm

Capacity curve, Hydrogen

Inlet pressure P = bar

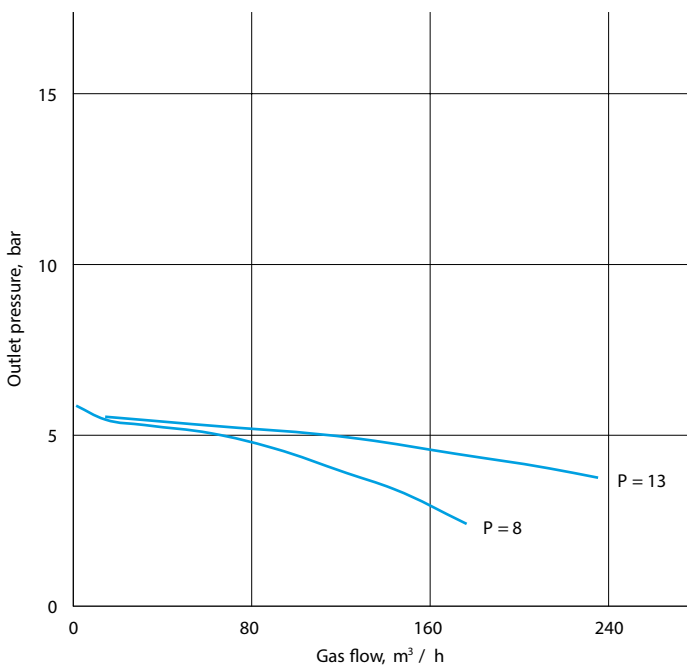

Gas	Max inlet pressure	Adjustment range	Article no.
Hydrogen	25 bar	0 - 10 bar	308894 (203 310 269)
Propane	25 bar	0 - 4 bar	309051 (203 310 270)

Tapping point – oxygen and combustible gases.

Double tapping point.

The JETSETapping point for fuel gas and oxygen provides a safe and stable gas supply. The tapping point unit is user-friendly and easy to service.

The double valve module, which is the unit's key element, is equipped with ball valves DN 10, and it is easy to see whether they are open or closed.

The inlet side has stainless steel pipe weld adapter as standard. Two UNICONTROL700 regulators are mounted on the underside of the valve module. These are adjustable within an appropriate range and provides stable outlet pressure. This tapping point comes with a Safe - Guard - 4 flashback arrestor for both fuel gas and oxygen as standard.

SAFE - GUARD - 4 flashback arrestor is a multi-function safety device with the following four functions:

- Non-return valve
- Flame filter
- Pressure sensitive shut-off valve
- Thermal shut-off valve

The tapping point has the following equipment:

Combustible gas

- Regulator UNICONTROL700
- Flashback arrestor SAFE - GUARD - 4
- Valve module with a stainless steel pipe weld adapter \varnothing 14 x 2.4 mm
- Hose connector 6,3 mm and 8 mm

Oxygen

- Regulator UNICONTROL700
- Flashback arrestor SAFE - GUARD - 4
- Valve module with a stainless steel pipe weld adapter \varnothing 14 x 2.4 mm
- Hose connector 6,3 mm and 8 mm



Gas	Max inlet pressure	Adjustment range	Article no.
Acetylene	1,5 bar	0 - 1,5 bar	301942 (203 310 238)
Oxygen	25 bar	0 - 10 bar	
Propane	25 bar	0 - 4 bar	330203 / 0785014
Oxygene	25 bar	0 - 10 bar	

Capacity curve UNICONTROL 700 Oxygen

Inlet pressure P = bar

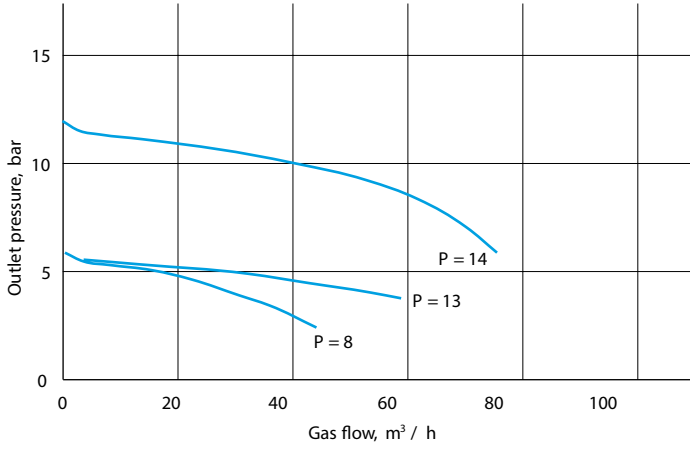

Capacity curve UNICONTROL 700 Acetylen

Inlet pressure P = bar

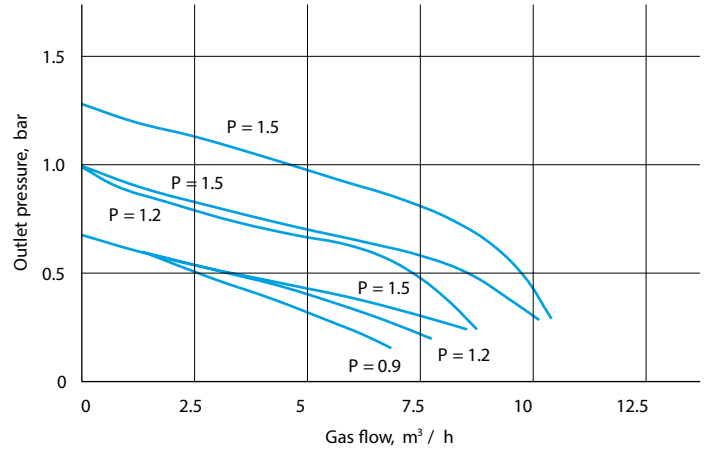

Capacity curve

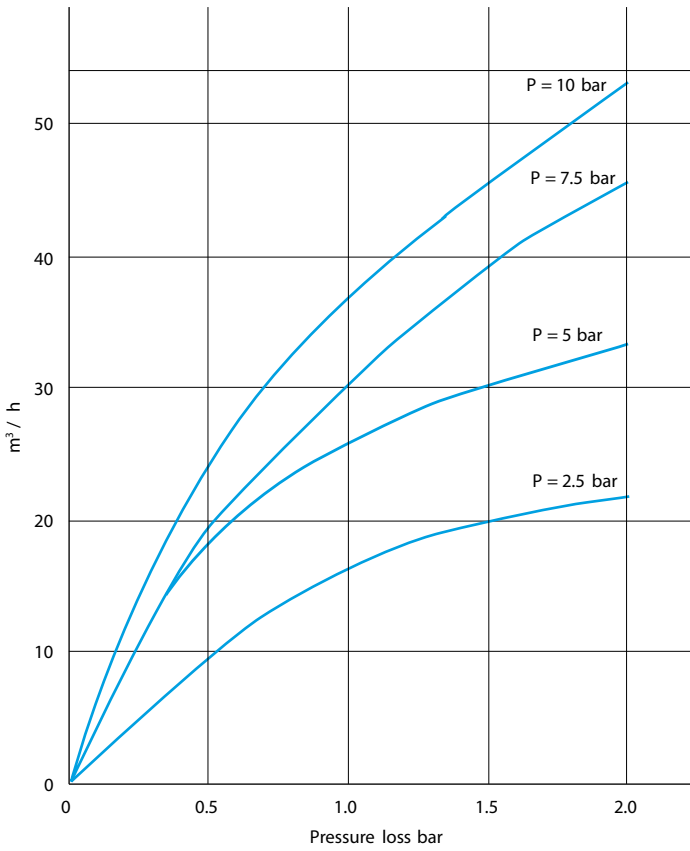

Capacity curve SAFE - GUARD - 4 Acetylene

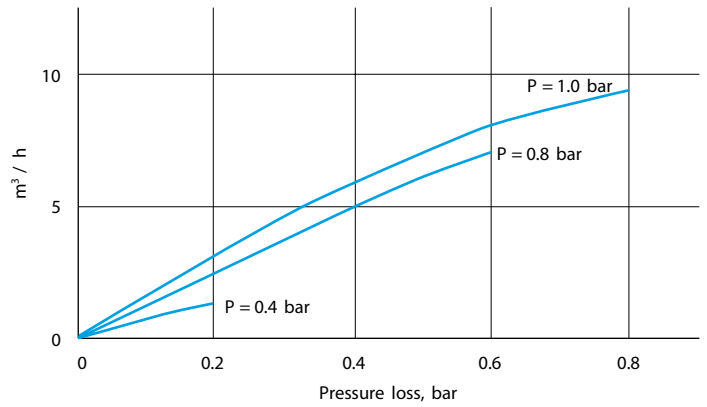

Tapping point - oxygen and combustible gases.

Single tapping points for machine cutting and other large consumers in oxy - fuel processes.

The single tapping points are designed for machine cutting. The outlet is user-friendly and easy to service.

The valve module, which is the outlet's key element, is equipped with a ball valve DN 10, and it is easy to see whether the valve is open or closed.

The inlet side has a stainless steel pipe weld adapter as standard. The S100 regulator is mounted on the underside of the valve module. This is adjustable within an appropriate range and provides stable outlet pressure.

All types are delivered with flashback arrestor.

The tapping point has the following equipment:

- Valve module with a stainless steel pipe weld adapter
- Ø 19 mm for oxygen
- Ø 15 for fuel gas
- Regulator S100
- Flashback arrestor GVx90 but 85-20 on oxygen 16 bar version
- Hose connector Ø 12,5 mm

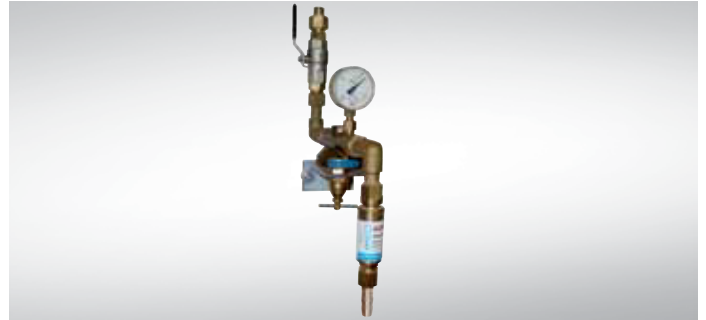

Gas	Max inlet pressure	Adjustment range	Article no.
Oxygen	30 bar	0 - 10 bar	330234 (0768171)
Oxygen	30 bar	0 - 16 bar	330237 (0768172)
Acetylene	1,5 bar	0 - 1,2 bar	330238 (0768173)
Propane	6 bar	0 - 4 bar	330239 (0768174)

Capacity curve oxygene

0768171

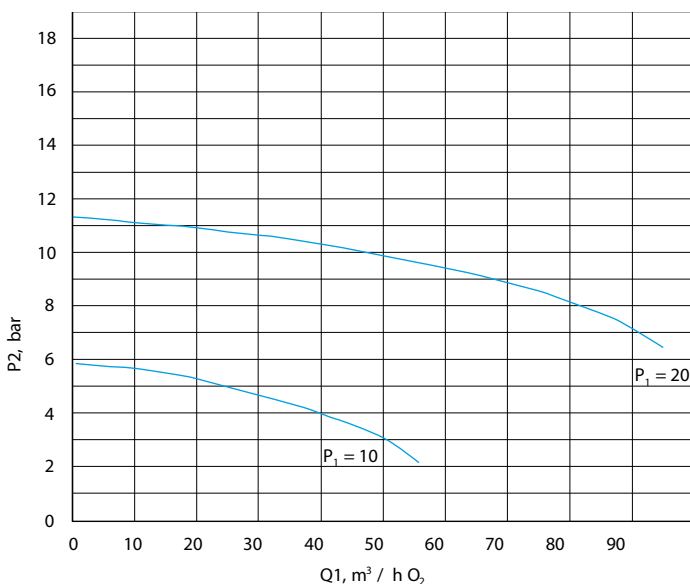

Capacity curve oxygene

0768172

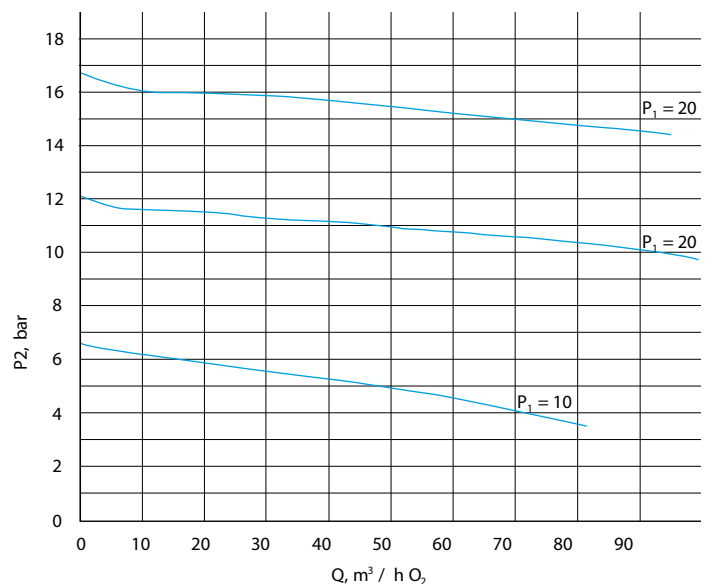

Tapping point - oxygen and combustible gases.

Triple tapping point for machine cutting.

Triple tapping point is designed to supply stationary cutting machines, where preheating oxygen and cutting oxygen should be supplied separately.

The tapping point provides a safe and stable gas supply. It is user-friendly and easy to service.

The valve module, which is the tapping points key element, is equipped with ball valves DN 10, and it is easy to see whether they are open or closed.

The inlet side has stainless steel pipe weld adapter as standard.

Regulators of the S100 type are mounted on the underside of the valve module. These are adjustable within an appropriate range and provides stable outlet pressure.

The tapping point comes with GV90 for heating oxygen and fuel gas, for cutting oxygen 85-20.



The tapping point has the following equipment:

- Regulator S100
- Flashback arrestor type GVx90 but 85-20 for oxygen 16 bar version
- Valve module with stainless steel pipe weld adapter
- Ø 19 mm for oxygen
- Ø 15 mm for fuel gas
- Hose connector Ø 12,5 mm

Gas	Max inlet pressure Oxygen	Max inlet pressure Combustible gases	Adjustment range cutting oxygen	Adjustment range Combustible gases	Adjustment range heating oxygen	Article no.
Oxygen + Acetylene	30 bar	1,5 bar	0 - 16 bar	0 - 1,2 bar	0 - 10 bar	330245 (0768175)
Oxygen + propane	30 bar	6 bar	0 - 16 bar	0 - 4 bar	0 - 10 bar	330246 (0768176)

Capacity curve acetylene

0768173

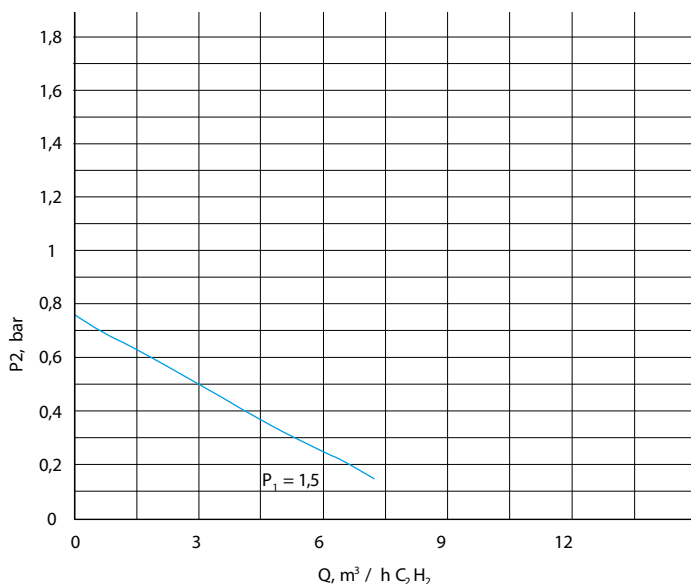

Capacity curve propane

0768174

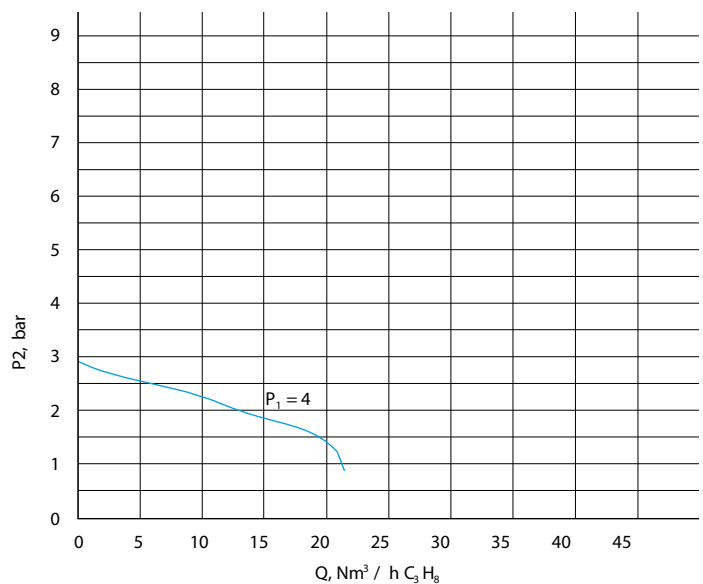

Tapping point oxygen.

Single tapping point for machine cutting.

Suitable for cutting machines with high consumption of cutting oxygen.

Gas supply from cryogenic tank for optimal capacity.

The regulator combined with the flashback arrestor type 85 - 30 according to our recommendation for safe and stable oxygen supply for oxy-fuel application. This tapping point type S200 for cutting oxygen is combined with one single tapping point for fuel gas and one single tapping point for heating oxygen. Both of type S100.

The complete unit can deliver above 100 nm³ oxygen per hour.

The outlet is equipped with:

Regulator S200

Flashback arrestor 85 - 30

DN 15 valve

Stainless steel pipe weld adapter Ø 18 mm on inlet

Hose connector 12,5 mm on outlet

Solid bracket for wall mounting

Weight 7 kg



Gas	Max inlet pressure	Outlet pressure	Article no.
Oxygen	30 bar	0 - 20 bar	321520 (0768085)

Mobile tapping point.

Argon and argon mixtures.

Mobile tapping point are used at ship yards and major mechanical workshops for outdoorwork in connection with non-permanent, multi-user gas supply systems.

Our mobile tapping point for argon and argon mixtures comes with tapping points for six users, which can be connected with quick connections for 6,3 mm welding hoses. The gas is feeded through a 19 mm hose to the inlet side of the unit. Two or more units can also be serie connected by hoses from one unit to another. It is recommended to install ball valves on the pipeline for easy and safe shut down in a emergency situation.

The tranportable tapping point have a very solid construction for long life time and rough handling.

The heavy frame ensure the unit don't tip over

Specifications:

- Width 80 mm
- Depth 30 mm
- Height 50 mm
- Weight 9 kg.
- Frame in stainless steel EN 1.4401
- Max. inlet pressure, 10 bar

The tapping point has the following equipment:

- One R 21 regulator permanently set for 4.5 bar
- Six flow meters 0 - 30 l / min with needle valves
- Outlet 6.3 mm hose connector
- Inlet R 1 1/4"
- Two-step quick connection at each outlet

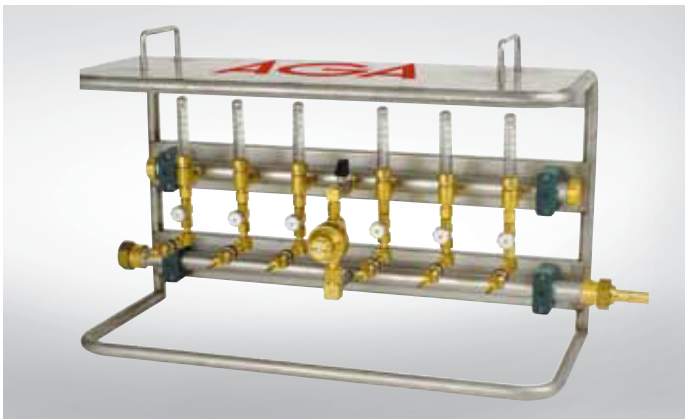

Description	Article no.
Mobile tapping point for argon and argon mixtures	303693
Accessories:	
Centre bit for 19 mm hose socket, to join up hoses	303659
Hose socket for 19 mm hose	303661
Two nuts for centre bit or hose socket,	301734 (202 502 270)
Blind nut	303638
Gasket for blind nut	303639
Gasket for 19 mm hose socket	303658
Glass to flow meter	300103

Mobile tapping point.

Acetylene and oxygen.

Mobile tapping point for acetylene and oxygen comes with tapping points for three users. Typical users are ship- yards, scrapp- cutters and other out - doors work.

Can also be delivered for propane and oxygen on request.

The gas is feeded through a 19 mm hose to the inlet side of the unit. Two or more units can also be serie-connected by hoses from one unit to another. It is recommended to install ball valves on the pipeline for easy and safe shut down in a emergency situation.

The tranportable tapping point have a very solid construction for long life time and rough handling.

The heavy frame ensure that the unit don` ttip over.

The solid R21 outlet regulator ensure the capacity and the the stability in flow.

Specifications:

- Width 780 mm
- Depth 330 mm
- Height 420 mm
- Weight 27 kg.
- Frame in stainless steel EN 1.4401
- Max. inlet pressure, oxygen, 25 bar
- Max. inlet pressure, acetylene, 1.5 bar

The tapping point has the following equipment:

Oxygen

- Shut-off valve
- Regulator R 21
- Flashback arrester RF 53
- Manometer
- Outlet 3/8" RH
- Inlet R 1 1/4"

Acetylene

- Shut-off valve
- Flashback arrester RF 53
- Needle valve
- Manometer
- Outlet 3/8" RH
- Inlet R 1 1/4"

Regulator oxygen.

Description	Article no.
Mobile tapping point for acetylene and oxygen	307434
Accessories:	
Centre bit for 19 mm hose socket, oxygen, to join up hoses	303659
Centre bit for 19 mm hose socket, acetylene gas, to join up hoses	303660
Two nuts for centre bit or hose socket, oxygen	301734 (202 502 270)
Two nuts for centre bit or hose socket, acetylene gas	301730 (202 502 269)
Hose socket for 19 mm hose	303661
Blind nut for oxygen	303638
Blind nut for acetylene 303640	
Gasket for blind nut	303639
Gasket for 19 mm hose socket	303658
Flashback arrester RF53 oxygen	303743
Flashback arrester RF53 acetylene	303740
T-piece with manometer oxygen	303703
T-piece with manometer acetylene	303726



Valve modules.

Single valve module for combustible gas

The valve module is the key element in a tapping point. Safety equipment and various regulators as needed can be fitted on the tapping point.

The valve module comes with DN 10 ball valve, brackets and a stainless steel pipe weld adapter EN 1.4301 of size $\varnothing 14 \times 2.4$ mm.

Single valve module for oxygen or non-combustible gas

The valve module is the key element in a tapping point that may be used for oxygen or non-combustible gases. A regulator, a flashback arrestor or a non return valve are fitted on the valve module.

The valve module comes with DN 10 ball valve, brackets and a stainless steel pipe weld adapter EN 1.4301 of size $\varnothing 14 \times 2.4$ mm.

Double valve module for combustible gas and oxygen

Heating and cutting processes require tapping points for both combustible gas and oxygen. To make the installation as simple as possible, a double valve module is used.

The valve module comes with DN 10 ball valves, brackets and stainless steel pipe weld adapter EN 1.4301 of size $\varnothing 14 \times 2.4$ mm.

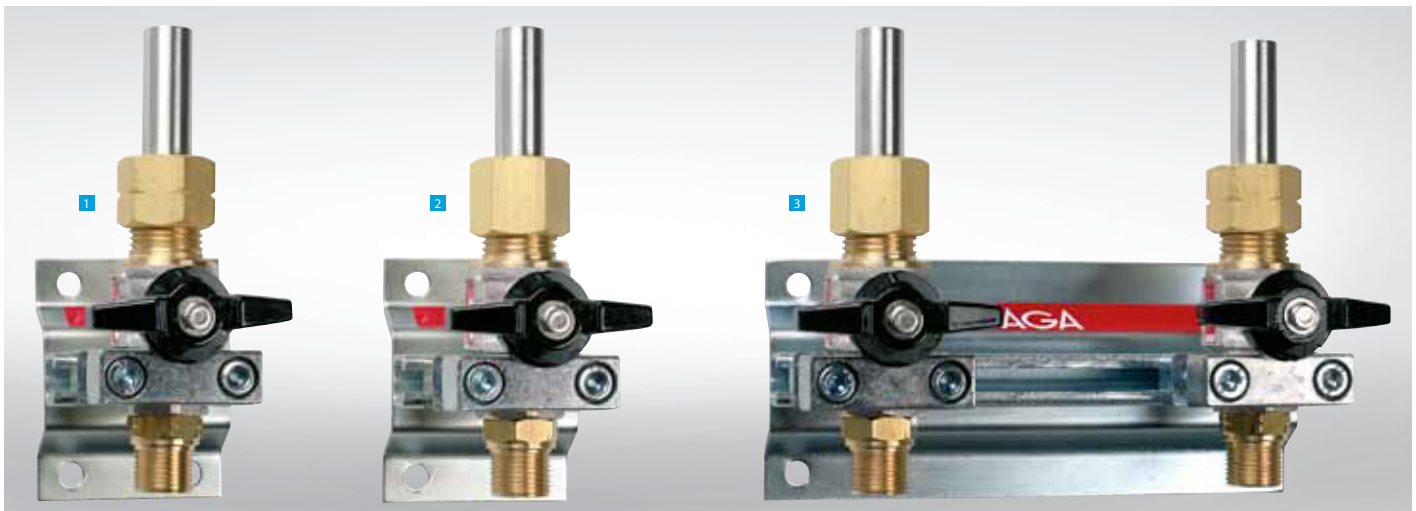

Pos	Description	Gas	Max. inlet pressure	Article no.
1	Single valve module	Combustible gas	25 bar	301929 (203 010 740)
2	Single valve module	Oxygen	25 bar	301682 (203 010 456)
3	Double valve module	Non- combustible+ oxygen	25 bar	301940 (203 010 741)

JETSETtapping point.

Accessories and spare - parts.

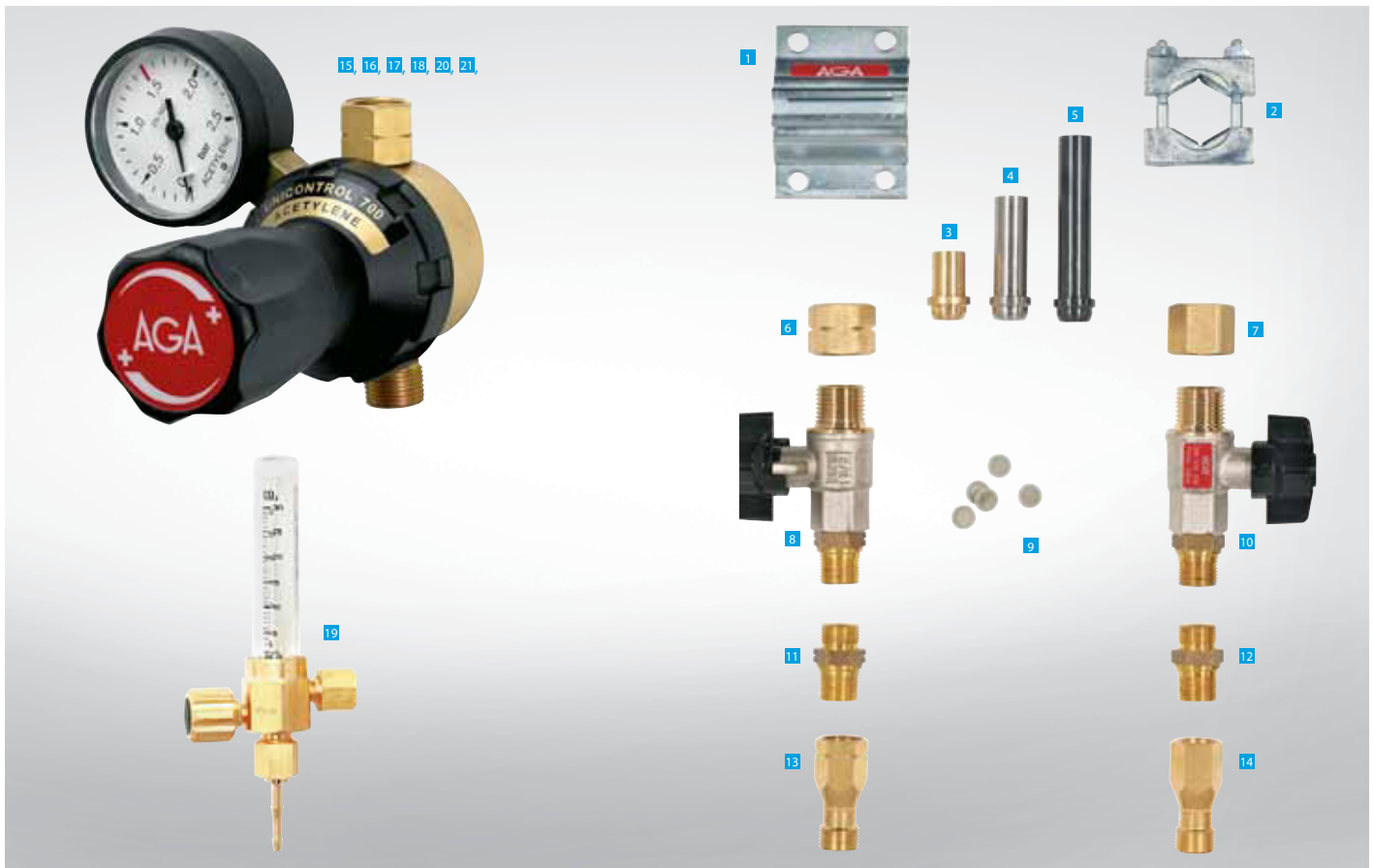

Pos	Description	Specifications	Article no.
1	Wall attachment for one outlet	55 mm	301667 (201 070 115)
	Wall attachment for two tapping points	160 mm	301653 (201 070 116)
	Wall attachment for three tapping points	210 mm	301669 (201 070 152)
2	Valve holder, complete		301673 (202 051 005)
3	Soldering sleeve, brass	for \varnothing 12 x 1.0 mm	301677 (201 032 407)
4	Pipe weld adapter, stainless steel	\varnothing 14 x 2,4 mm	307652 (201 033 082)
5	Pipe weld adapter, steel pipe	\varnothing 14 x 2,4 mm	303700 (201 032 371)
6	Couplingnut, combustiblesgas	G 1/2" LH	301896 (201 020 899)
7	Couplingnut, oxygen	G 1/2" RH	303709 (201 020 898)
8	Ball valve with filter, combustiblesgas	G 1/2" LH - G 3/8" LH	301670 (203 010 664)
9	Filter, 10 pc		301982 (202 500 154)
10	Ball valve with filter, oxygen	G 1/2" RH - G 3/8" RH	301671 (203 010 614)
11	Outlet nipple, combustiblesgas	G 3/8" - G 3/8" LH	303719 (215 191 049)
12	Outlet nipple, oxygen	G 3/8" - G 3/8" RH	303702 (215 191 048)
13	Non-return valve, combustiblesgas	G 3/8" LH	310531 (215 191 102)
14	Non-return valve, oxygen	G 3/8" RH	303722 (215 191 097)
15	Regulator, UNICONTROL700 oxygen	Outlet pressure 0 - 10 bar	301811 (203 005 306)
16	Regulator, UNICONTROL700 acetylene	Outlet pressure 0 - 1.5 bar	307245 (203 005 307)
17	Regulator, UNICONTROL700 argon	Outlet pressure 2,5 bar	301826 (203 005 280)
18	Regulator, UNICONTROL700 hydrogen	Outlet pressure 0 - 10 bar	310477 (213 003 280)
19	ROTAMPLUS flow meter	30 l / min.	300100 (203 009 121)
20	Regulator UNICONTROL700, Argon	0 - 30 l / min	323197 (0 783 193)
21	Regulator UNICONTROL700, Propane	Outlet pressure 0 - 4 bar	310439 (203 005 308)

Alarm system.

Gas supply monitoring GL 2000.

AGA's alarm system GL 2000 is used to achieve a stable and continuous gas supply to the consumersites by monitoringthe gas pressure in the cylinders.

In its simplest version, the alarm system consists of an alarm panel and pressure sensors. The alarm unit has a visual as well as an acoustic alarm, and the alarm panel shows which inlet is giving rise to the alarm. The sensors, normally contact gauges or pressure transmitters, should be installed to the high pressure side of the manifold.

The alarm unit can be placed as desired, in the control room or close to the employees who monitorthe gas cylinders.

The alarm system can be expanded in a numberof ways. It may be connected to up to 56 digital inputs or up to 26 analogue inputs, giving a total of 82 alarms when the system is fully expanded.

The system may be supplied with a modemfor external monitoring,or it can be connected to a central operations monitoringsystem. This alarm system is normally used for customers with SECCURA automatic gas supply, where Lindømonitors the gas level in your central gas manifold and ensures that full cylinders are delivered at the right time.

For GL 2000 you can choose between:

A alarms

that are used locally and make use of outlet relays 1 and 3. An A alarm can be a non-critical alarm, e.g. to let you know that one side of a semi-automatic central manifold is empty.

B alarms

that are used in connection with SECCURA .

C alarms

that are used locally and make use of outlet relays 1 and 2.

A C alarm can be a critical alarm, e.g. to let you know there is no pressure on the network.

GL 2000 without use of expansion modules have the possibility for connection of:

Eight contact gauges or pressostats, digital inlet.

Two pressure transmitters, analogue inlet.

Four outputsrelays.

If still more inputs are needed, the alarm system can be extended with:

Up to three digital extension units. Sixteen digital inputs per unit, i.e. a total of 56 digital inputs.

Up to three analogue extension units

Eight analogue inputs per unit, i.e. a total of 26 analogue inputs.

The GL 2000 must be connected to 230 V AC.

Extension elements and Ex-relay must have a 24 V DC power supply.

The relay outputs indicate:

1. Sound/ light to e.g. an extra lamp
2. Calarms
3. A alarms
4. Connection/ functional (live)

The alarm systems should be programmed by Linde.

The alarm unit must be installed by an Linde authorized electrician.

The GL 2000 may be combined with AGA's SECCURA service which provides automatic gas supply by installed GSM modem.



Description	Technical data	Article no.
Alarm unit GL - 2000	8 digital and 2 analogue inputs	310082
Digital extension unit	Extension with 16 digital inputs	307411 (400 000 002)
Analogue extension unit	Extension with 8 analogue inlets	307412 (400 000 003)
Ex-relay, digital	4 inputs and 4 outputs	307410 (400 000 004)
Ex-relay, analogue	1 input and 1 output	309057
Ex-relay, analogue	2 inlets and 2 outlet	309058
Power supply	Used for the extension modules	307960
Cable monitoring unit	For 2 contact manometers	307961 (501 002 150)
Analogue modem, GL 2000	For integration in GL 2000	310081
GSM modem, GL 2000	For integration in GL 2000	310080

Alarm system.

Gas supply monitoring AB - 8.

Local alarm to monitor the gas pressure in the cylinders. The alarm unit has 8 alarm inputs.

When an alarm happens, alarm LED lamp starts blinking and a sound turns on. When the alarm reset button is pushed, the alarm sound goes off and alarm lamp stops blinking and stays constantly on. Every new alarm, which is not acknowledged, is indicated by the blinking lamp and alarm sound. If the alarm goes off, also alarm indication goes off.

Every new alarm triggers also a delayed common alarm relay signal to external alarm system. Alarm reset button is also a LED test button. While pushing the button, all alarm lamps go on. Every channel has a space for alarm text labels in the front plate.



Technical data

- 8 binary channels
- Inductive, NAMUR or mechanical alarm contacts
- Opening or closing contacts
- Internal alarm buzzer
- Delayed common alarm output relay (5 sec delay)
- Operating voltage 230 VAC, 32 mA or 24VDC selectable
- Input channel voltage typically 11V (6 mA)
- Common alarm relay opening or closing contact max 24V DC / AC 0,5A SELV, delay 5 sec.
- Temp. 0 - 40° C
- Protective class IP30
- Dimensions 110 x 180 x 89 mm (W X H X D)
- Alarm cable like NOMAK, shield connected to common terminal
- Main cable 1,5 mtr. included

System	Article no.
AB - 8	330083

Contact gauge.

The contact gauge can be fitted on the high pressure side of your central gas manifold in order to monitor the cylinder pressure.

The manometer contacts can be preset to a desired alarm pressure for replacing the cylinder. It can be connected to the GL 2000 alarm or the AB - 8 alarm unit.

The contact gauge is installed in an appropriate place on the high pressure side of your central gas manifold.

When the contact gauge is used for combustible gases, an Ex-relay must be fitted outside the central gas manifold and blue coloured cables be used.

The electrical installation must be done by an authorized electrician.

Technical data:

Manometer size Ø 63 mm

Potential free contact type, normally closed

Bottom entry

Housing in stainless steel 316

IP54



Product	Scale	Connection	Article no.
Contact gauge	0 - 5 bar	1/4" NPT	321372
Contact gauge	0 - 15 bar	1/4" NPT	321371
Contact gauge	0 - 40 bar	1/4" NPT	321364
Contact gauge	0 - 100 bar	G 1/4"	321374
Contact gauge	0 - 315 bar	G 1/4"	323558
O - ring			321370
Adapter		G 1/4" - 1/4" NPT	323557

Signs and labelling.



Gas under pressure

Mount this sign on the door to your central gas manifold.

Description	Measure mm	Article no.
Gas under pressure	210 x 210 x 210	308552 (215 191 135)



Ex area

Mount this sign on the door to your central gas manifold for combustible gases.

Description	Measure mm	Article no.
Ex area	210 x 210 x 210	316731 (215 191 161)



No smoking

Mount this sign on the door to your central gas manifold for combustible gas.

Description	Measure mm	Article no.
No smoking	210 x 210	308551 (215 191 136)

Getting ahead through innovation.

With its innovative concepts, Linde's playing a pioneering role in the global market. As a technology leader, our task is to constantly raise the bar. Traditionally driven by entrepreneurship, we are working steadily on new high-quality products and innovative processes.

Linde offers more. We create added value, clearly discernible competitive advantages and greater profitability. Each concept is tailored specifically to meet our customers' requirements – offering standardized as well as customised solutions. This applies to all industries and all companies regardless of their size.

Linde – ideas become solutions

Sweden
Linde Gas AB
www.linde-gas.se

Norway
Linde AS
www.linde-gas.no

Iceland
ISAGA ehf
www.linde-gas.is

Latvia
Linde SIA
www.linde-gas.lv

Finland
Oy Linde Ab
www.linde-gas.fi

Denmark
Linde A/S
www.linde-gas.dk

Estonia
AS Eesti Linde
www.linde-gas.ee

Lithuania
Linde UAB
www.linde-gas.lt